

TABLE OF CONTENTS

TABLE OF CONTENTS	1
Chapter 1 – YOUR NEW ORION II	
ORION II – ANOTHER STEP FORWARD IN TEN-TEC INNOVATION	4
UNPACKING YOUR NEW ORION	4
ABOUT THIS MANUAL	4
CONNECTING A POWER SUPPLY	4
A WORD ABOUT GROUNDING	5
HOW IS ORION II DIFFERENT FROM OTHER HIGH-PERFORMANCE HF TRANSCEIVERS?	5
Chapter 2 – ORION II FRONT AND REAR PANEL CONTROLS AND THEIR FUNCTIONS	
ANALOG METER	7
(1) POWER	7
(2 – 7) ANTENNA ASSIGNMENTS	7
(8 – 13) VFO ASSIGNMENTS	8
(14) MIC	9
(15) PHONES	10
(16) CW	10
(17) PWR	11
(18) MON	11
(19) SP	11
(20) SEND FUNCTIONS	11
(21) USER 1 AND USER 2	12
(22) RECALL	12
(23) NB	13
(24) NR	13
(25) NOTCH	14
(26) AN	14
(27) MODE	14
(28) PREAMP	14
(29) RF GAIN	14
(30) SPOT	15
(31) STEP	15
(32) SWEEP	15
(33) AGC	15
(34) ATTN	15
(35) MENUS	16
(36) AUDIO	16
(37) VOX	18
(38) S-TONE	18
(39) MIC	18
(40) TUNE	18
ALC	19
BARGRAPH	19
(41) PBT/BW ENCODER	20
(42) MULTI ENCODER	20
(43) HI CUT – LO CUT	20
(44) MAIN AF ENCODER	21
(45) SUB AF ENCODER	21
(46) RIT/XIT ENCODER	21
(47) MAIN TUNING KNOB “A”	21
(48) RIT	21
(49) VFO A>M	21

(50) and (51) LCK	22
(52) VFO B>M	22
(53) XIT	22
(54) MAIN TUNING KNOB "B"	22
(55) MAIN RX	22
(56) SUB RX	22
(57) FREQUENCY ENTRY AND BAND CHANGE BUTTONS	22
(58) VFO A ENTER	22
(59) VFO B ENTER	23
(60) A>B, B>A, A/B	23
(61) ANT 1	24
(62) ANT 2	24
(63) DC IN	24
(64) FUSE 25 A	24
(65) GND	24
(66) AMP KEY 1	25
(67) TX OUT 1 / TX EN 1	25
(68) AMP KEY 2	25
(69) TX OUT 2 / TX EN 2	25
(70) +13.8 VDC	26
(71) AUX RX	26
(72) XVRT KEY	26
(73) XVRT RF	26
(74) LINE OUT	26
(75) SPARE	26
(76) BAND DATA 1	26
(77) BAND DATA 2	26
(78) EXT SPKR	27
(79) KEY	27
(80) AUX I/O	27
(81) REMOTE	28
(82) SERIAL DATA	28

Chapter 3 – MENU SYSTEM

(TX) TX MENU	29
(CW) CW MENU	30
(VOX) VOX MENU	31
(RX) RX MENU	32
(OTHER) OTHER MENU	33
(SSB) SSB MENU	34
(FILTR) FILTER MENU	35

Chapter 4 – OPERATION AND ACCESSORY CONNECTION EXAMPLES

BASIC TRANSCEIVE OPERATION	37
OPERATING SPLIT FREQUENCY	37
OPERATING THE AUTOMATIC ANTENNA TUNER (IF INSTALLED)	38
CONNECTING AN EXTERNAL LINEAR AMPLIFIER	38
TUNING UP AN EXTERNAL LINEAR AMPLIFIER	39
FACTORS THAT AFFECT THE SOUND OF SSB TRANSMIT AUDIO AND THEIR ADJUSTMENT	39
SETTING UP ORION II FOR AM TRANSMIT	42
FSK OPERATION	42
TRANSVERTER HOOKUPS	42
DIVERSITY RECEPTION	43

WEAK SIGNAL DX RECEPTION AND CONTEST OPERATION AND THE ORION II	44
EXTERNAL CW OUTPUT PLUS CW KEYER OPERATION FROM PADDLES	48
DRAG ADJUSTMENT FOR MAIN TUNING KNOBS "A" AND "B"	48
INSTALLATION OF OPTIONAL CRYSTAL ROOFING FILTERS	48
MASTER RESET	49
UPDATING ORION II OVER THE INTERNET	49
TROUBLESHOOTING	49

Chapter 5 – SPECIFICATIONS AND TECHNICAL DESCRIPTION

SPECIFICATIONS	52
HARDWARE INFORMATION	56
SUBASSEMBLY LOCATION	56
SIGNAL PATH – MAIN RECEIVER	56
SIGNAL PATH – SUBRECEIVER	57
SIGNAL PATH – TRANSMITTER	57
BLOCK DIAGRAMS AND CABLE ROUTING	58

Chapter 1 – YOUR NEW ORION II

ORION II – ANOTHER STEP FORWARD IN TEN-TEC INNOVATION

The Ten-Tec ORION II represents the most innovative HF transceiver ever created for amateur radio use.

Our aim in designing and producing this radio was to meet the demands of increasingly intense competition in DX and contesting, while adding many non-performance related features that the active ham can also appreciate. The features and performance ORION II brings to ham radio will enhance HF radio contacts of all sorts, while opening new possibilities for amateur radio operation. ORION II offers world-class reception and transmission of CW, SSB, digital modes, FM, and AM on all 10 HF amateur bands, plus excellent general coverage reception via the second (sub) receiver from 100 kHz to 30 MHz.

UNPACKING YOUR NEW ORION II

Examine ORION II for signs of shipping damage. Should any damage be apparent, notify the delivering carrier immediately, stating the full extent of the damage.

Retain all damaged cartons. Liability for shipping damage rests with the carrier. We recommend that you keep the carton and fillers in the event that storage, moving, or shipment becomes necessary.

The following hardware and accessories come standard with your ORION II. Make sure that you have not overlooked anything.

Qty	Part #	Description
1	#27074	Mini-ATC Blade Fuse, 25 Amp.
1	#35003	Phono Plug
1	#35363	8-pin Microphone Connector
1	#35241	8 pin DIN socket
1	#35165	2-pin Power Connector Shell
2	#41020	Female Power Pins
1	#35017	Phone Plug, 3-circuit
1	#35331	Shell, Band Data Plug
15	#41068	Band Data Plug Pins
1	#38040	.050 Hex Wrench
1	#38088	.062 Hex Wrench
1	#38313	T10 Torx Wrench
1	#46172	Serial Cable
1	#46176	Accessory Cable. 5-pin DIN to phono female
1	#74020	Warranty Card
1	#74410	User's Manual
1	#86095	DC Power Cord

Figure 1-1 ORION II Packing Kit

ABOUT THIS MANUAL

The ORION II is a firmware updateable transceiver. Features and functions on the transceiver can change as time passes when new firmware revisions are issued via Ten-Tec's www.rfsquared.com firmware download website. The latest version of the ORION II manual is posted in .pdf format on the ORION II section of the Ten-Tec website at www.tentec.com

This manual was written by
Scott E. Robbins, W4PA.

CONNECTING A POWER SUPPLY

The ORION II transceiver requires a source of well-filtered and regulated DC voltage. The supply voltage can range from +12.8 to +15.0 Vdc but +13.8 Vdc is the optimum

value. The voltage source must be capable of supplying 22 amperes continuous duty.

We recommend using the included DC power cable (P/N 86095). We have also included spare connector pins (P/N 41020) and a spare 2 pin power connector shell (P/N 35165) for building your own cable. The power supply plug will attach in only one direction to the polarized two-pin DC connector on the ORION II rear panel. Use no less than #14 gauge (#12 recommended) stranded wires for three-foot long connections to accommodate the required current demand during transmit. Use heavier gauge wire for longer power supply leads.

NOTE: always enable the power source first and then the transceiver. If a generator or alternator supports the dc source, always turn off the transceiver before starting or shutting off the dc source equipment. These recharging devices often generate large voltage spikes that can damage the transceiver.

A WORD ABOUT GROUNDING

A good ground system is essential for optimum operation of any HF transmitter. The best solution is to connect all the station equipment chassis together using a heavy gauge of flat ground braid. Use a short length of braid to connect to a ground rod. If you are not using a linear amplifier, a less ideal ground may suffice. A ground connection to a copper cold water pipe was often suitable, but that is now a violation of the National Electrical Code. Be aware that many modern water connections use plastic pipe, and are not suitable ground connections.

Antenna type and its proximity to the station are also factors in choosing ground methods. With good resonant antennas located away from the station, the AC ground in your house wiring might be adequate.

HOW IS ORION II DIFFERENT FROM OTHER HIGH-PERFORMANCE HF TRANSCEIVERS?

ORION II is different from HF transceivers that have come before it. The original

ORION transceiver pioneered the use of mode-appropriate selectable crystal roofing filters at the first I-F stage plus DSP bandwidth filtering at the third I-F stage. The ORION II features an even more advanced roofing filter stage than the original ORION for optimum receiver performance.

The mode-appropriate roofing filters used in the ORION II main receiver are the centerpiece of the radio's performance. It is common for radio designers to be able to produce a receiver that exhibits in excess of 100 dB of available dynamic range. What is not common is the ability to protect superior receiver design from being compromised by real-life on-band factors (i.e. loud close by signals).

Mode-appropriate roofing filters keep close by loud signals from having a negative impact on receiver performance. A typical high performance HF transceiver is equipped with a 15 to 20 kHz wide roofing filter at the first I-F stage. Any signal that appears under the 15 to 20 kHz roofing filter, *even if you do not hear it in your receiver passband*, has the potential to compromise receiver performance. Loss of dynamic range, third-order intercept or the receiver breaking into non-linearity (distortion) are possible results.

When dynamic range and third-order intercept are compromised, the ability to copy weak signals is also compromised. The typical 100 dB dynamic range high performance HF radio, in the presence of loud signals a few kHz above or a few kHz below the targeted receiver frequency, could lose a significant amount of the available 100 dB of range! Why? Because those loud signals under the 15 to 20 kHz wide roofing filter have had a negative impact on the overall performance of the receiver.

If a mode-appropriate roofing filter is substituted for the 15 or 20 kHz wide roofing filter at the first I-F, the result is that close by loud signals *do not* compromise dynamic range or third-order intercept point. A 2.4 kHz crystal filter will not allow loud signals that are 3 or 5 kHz away from the target frequency compromise the overall performance of the receiver. This is where

every other HF transceiver that has come before ORION II is deficient. Imagine how much worse the receiver performance of a competitor's radio can be in the presence of many loud signals across the band (like in a major contest).

ORION II is equipped with a total of seven available crystal roofing filter slots. Four of the seven crystal roofing filters are standard; three are optional. The standard roofing filters included are 20 kHz, 6 kHz, 2.4 kHz, and 1 kHz. Optional filters are available at 1.8 kHz (model 2000), 600 Hz (model 2001) and 300 Hz (model 2002).

Note that the 20 kHz and 6 kHz roofing filters are of limited utility for maintaining the overall receiver performance level of a high end HF transceiver like ORION II. They were included only because AM and FM operation would require them, and because some operators with an interest in "hi-fidelity" SSB audio will require receiver bandwidths higher than the typical 2.4 kHz communications grade roofing bandwidth would allow. Certainly the use of either a 20 kHz or 6 kHz wide roofing filter has the potential to allow overall receiver performance (dynamic range and third-order intercept point) to be seriously compromised by loud close by signals. For serious receiver use, like weak signal DXing and contesting, a much smaller roofing bandwidth than 20 or 6 kHz is necessary. In ORION II for SSB use, it can be as little as 1.8 kHz for roofing. For CW, it can be as little as 300 Hz, depending on the installation of optional filters.

For some recommended real-world examples of how roofing filters affect overall receiver performance, please look at recent ARRL Product Reviews from QST magazine where dynamic range and third-order intercept are measured at 20 kHz and 5 kHz signal spacings. For our competitors' transceivers, the 5 kHz spacing numbers are always significantly worse than the 20 kHz spacing numbers – this is because of the presence of test signals under a 15 to 20 kHz wide roofing filter vs. outside the filter.

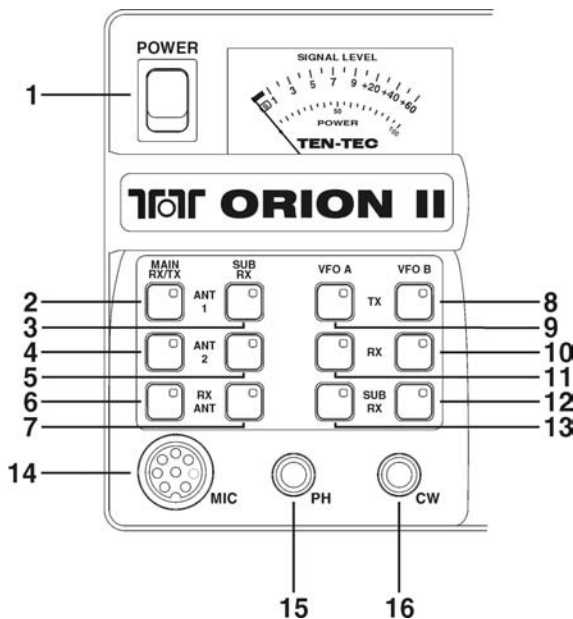

Chapter 2 – ORION II FRONT AND REAR PANEL CONTROLS AND THEIR FUNCTIONS

Chapter 2 of the ORION II manual covers the various controls and connectors on the front and rear panels, with an explanation of the each control and how it is used for operation of the radio.

ANALOG METER

An analog meter is provided at the upper left hand side of the front of the transceiver. In receive, the meter shows S-units of signal strength for the main receiver.

In transmit, the meter shows approximate output power (+/- 5%). The power meter is a sampling-type meter and will stay more or less constant when sampling power output, particularly when the transceiver is used in CW mode.

A separate bar graph S-meter for the subreceiver is present on the radio screen.

(1) POWER

This button turns the transceiver on and off.

(2 – 7) ANTENNA ASSIGNMENTS

The two columns of antenna selection keys (numbered 2 through 7 in the figure above) allow the assignment of up to three connected antennas to each of the two receivers.

The most common arrangement would be to have a single antenna connected to ANT 1 used by either the main receiver only, or by the main receiver and the subreceiver both.

Buttons 2, 4 and 6, as shown above, allow ANT 1, ANT 2 or RX ANT to be connected to the main receiver.

To connect an antenna attached to the transceiver via the ANT 1 rear panel jack to the main receiver, press button 2 shown above. The amber LED embedded in the button will light, indicating the main receiver is now connected to ANT 1.

Pressing button 4 as shown above will connect the main receiver to ANT 2.

When either of the ANT 1 or ANT 2 buttons in the MAIN RX/TX column is lit, a receive only antenna can be substituted for the receive side of ANT 1 or ANT 2 by pushing button 6 as shown in Figure 2-1.

Example: With button 2 or button 4 lit, press button 6. The operator will note that there are now two lighted buttons in this column, either of 2 or 4, plus 6. The radio will automatically use either ANT 1 or ANT 2 for transmit and RX ANT for receive in this configuration.

Buttons 3, 5, and 7 control the assignment of the subreceiver to each of the antennas connected to the radio. The subreceiver can either share the same antenna in use for the main receiver, or it can be split off to used with a separate antenna.

An antenna attached to ANT 1, ANT 2, or RX ANT can be used simultaneously with both receivers or they can be split off to separate receivers. One receiver cannot be used with two antennas at the same time. One antenna + one receiver, two antennas +

two receivers, One antenna + two receivers are the available selections. Additionally, button **2** is used for performing a master reset of the transceiver. See the **MASTER RESET** description in Chapter 4.

(8 – 13) VFO ASSIGNMENTS

While dual receive transceivers are common today, ORION II allows an unprecedented level of flexibility to the operator for main and subreceiver control with the VFO assignment buttons. Receivers can be assigned to separate VFO's (the most common arrangement) or both receivers can be assigned to a single VFO.

The operator is permitted to assign each VFO to either receiver and the transmitter. VFO's can be adjusted even if NO receiver is selected for them.

The two large tuning knobs are for each VFO. The large knob on the left closest to the display screen is always VFO A, the large knob to the right is always VFO B.

Buttons **8** and **9** determine which VFO the transmitter is assigned to. The TX frequency also determines the output of the BAND DATA connectors on the ORION rear panel (see description of **76** BAND DATA 1 and **77** BAND DATA 2 elsewhere in this manual).

Buttons **10** and **11** determine which VFO the main receiver is assigned to.

Buttons **12** and **13** determine which VFO the sub receiver is assigned to.

The assignments of the VFO's are not only shown by the amber LED's inside the buttons, and are announced on the display screen. Shown in Figure 2-2 below is a default screen when powering up ORION after a master reset.

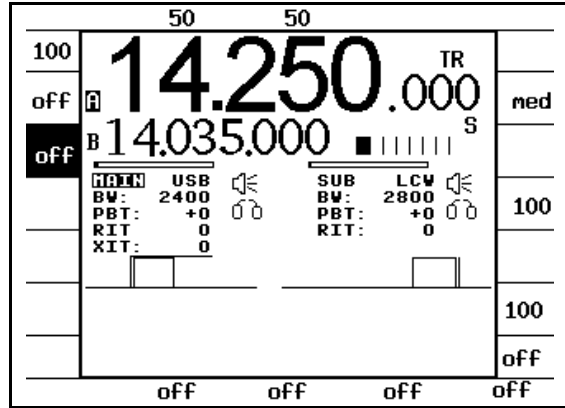

Figure 2-2 ORION II Screen Display

Refer to Figure 2-2. Next to the 14.250.000 frequency display for VFO A are the letters TR. 'T' is for transmitter, 'R' is for main receiver, and 'S' is for sub receiver. As the operator assigns the transmitter and receivers using buttons **8** through **13**, the T R and S indicators will move back and forth on the screen. If a transmitter or receiver has no assignment, the annunciator will not be shown.

The main receiver and the transmitter are amateur bands-only coverage. An attempt to assign them to a frequency outside the ham bands will result in one of three messages appearing on the screen: VFO-A OUTSIDE RX RANGE, VFO-B OUTSIDE RX RANGE or FREQUENCY NOT SUPPORTED depending on how the user was attempting to put the main receiver on a non-amateur frequency.

Buttons **8** and **9** can be used to turn the transmitter off by deselecting both buttons. Push **8** and **9** so neither light is lit. The T indicator will not be present on the screen.

Buttons **12** and **13** can be used in a similar fashion to deselect the subreceiver, but there will still be audio present through the subreceiver audio chain on the last used subreceiver frequency when doing so – it will not mute the subreceiver. Subreceiver audio can be muted by turning the SUB AF encoder all the way counterclockwise or by pressing it to mute. After no VFO is assigned to the subreceiver, the last subreceiver frequency will still be audible.

The main receiver cannot be disabled; it will always be assigned to either VFO A or VFO B via buttons **10** and **11**.

Receivers can be assigned to one VFO or the other simultaneously. There are advantages to doing so – see section the section of Chapter 4 called **DIVERSITY RECEPTION** for information on diversity receive capabilities using the two receivers, the VFO's and multiple antennas.

(14) MIC

Jack used for connection of microphone. The ORION II features the common 8 pin microphone jack used by amateur radio transceivers. Most dynamic or electret microphones can be used. When adapting a microphone, please refer to the wiring diagrams in Figures 2-3 and 2-4. We include a spare 8-pin microphone connector (P/N 35363) with the packing kit to allow rewiring of your current mic for use with ORION II. The pinout for the 8 pin mic connector on the front of the ORION II is shown in Figure 2-3. Recommended wiring is shown below in Figure 2-4.

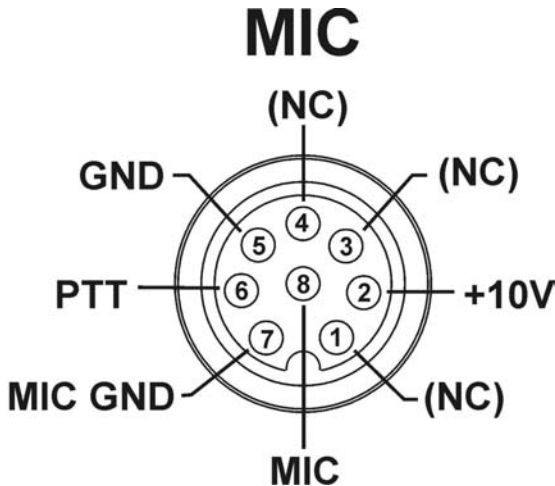
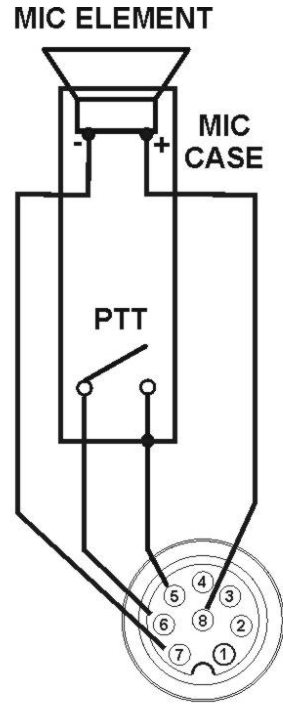

Figure 2-3 Front view, mic connector, on front panel of ORION II

It important that the microphone body have a common ground with the ORION II. We recommend wiring microphone cables as shown in Figure 2-4.



TRANSCEIVER MICROPHONE JACK FRONT VIEW

Figure 2-4 Recommended mic cable wiring.

Pin 2 (+10 VDC) need only be connected if the microphone element in use is an electret condenser requiring a polarizing voltage.

Keeping chassis ground and mic signal ground separated are done to reduce the possibility of introducing stray hum or RFI into the transmit audio signal.

Note we recommend that the case of the microphone also be tied to chassis ground on the transceiver via pin 5. This is to help assure stray RF does not have a path to be coupled into transmit audio.

Some microphones are not wired to separate microphone signal ground from chassis ground, and the two are tied together. We recommend separate pins for use for mic negative signal and chassis ground as shown in Figure 2-4.

(15) PHONES

DO NOT PLUG A MONO PHONE PLUG, (two-circuit) INTO THE ORION II FRONT PANEL PHONES JACK UNLESS PROPERLY WIRED AS DESCRIBED !

The PHONES jack is optimally for stereo headphones. ORION II uses left and right stereo outputs from two audio amps. A mono plug will short-circuit one of the two audio channels, causing damage to the radio. Use a stereo (3-circuit) plug such as one that comes packed with your radio. Using stereo headphones lets you take full advantage of ORION II's advanced features.

Audio from the front panel phones jack to a stereo connector is left = tip, right = ring, ground = sleeve.

Mono headphones can be used with ORION II, provided they are wired correctly with a stereo plug and the headphone audio settings in the AUDIO menu are set to the appropriate values. You can use left side audio output to mono headphones by wiring the headphones as shown in Figure 2-5. See **(36) AUDIO** later in the manual for adjusting the headphone output for mono headphones as wired below.

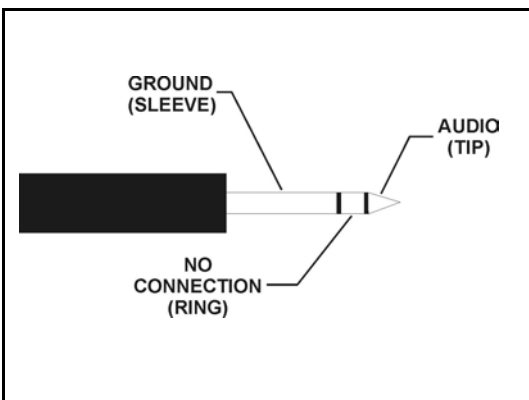

Figure 2-5 Wiring Mono Headphones

(16) CW

ORION II has two jacks for keying the transceiver in CW mode. The front panel provides a 1/4" stereo jack for connection of an external key, keyer, or paddles. See Figure 2-6 for proper wiring. The rear panel has a 1/8" stereo jack connected in parallel

(see description of **(79) KEY** later in the manual). ORION II on initial power-up has its internal keyer disabled. To use the internal keyer in a CW mode, press the SP button ('Speed') and then rotate the MULTI knob for an appropriate CW speed (Note: In SSB modes, SP is used for speech processing and displays a different value).

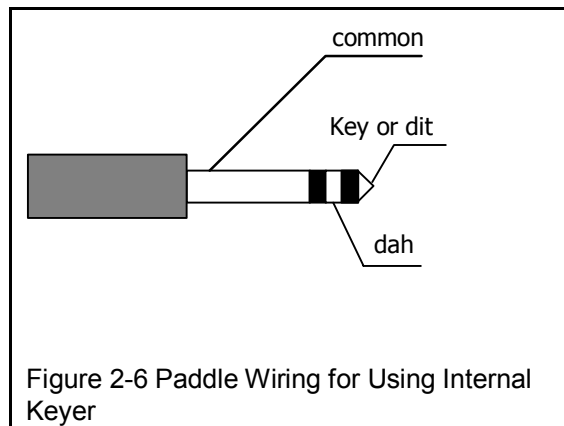
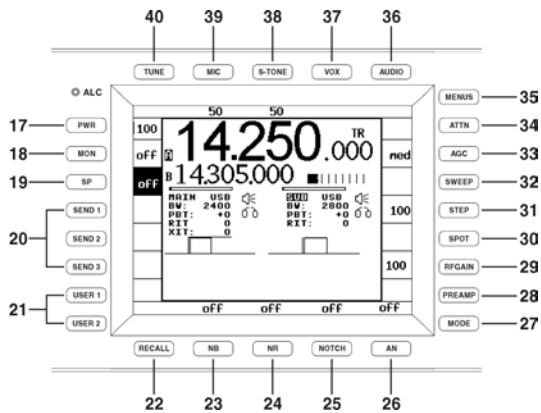

Figure 2-6 Paddle Wiring for Using Internal Keyer

The PTT pin (3) on the AUX I/O rear jack or the PTT connection on the microphone jack may allow you to connect an independent keyer or computer to share CW keying depending on how this jack system has been configured via the menu system.

This would be useful if using the output of a computer program (like contest logging software) while also desiring a paddle to be connected to the radio for using the internal keyer. Connect the CW keying output of the computer logging program to PTT pin (3) on the AUX I/O jack or the microphone jack, and then connect your paddle to either of the two panel mounted CW jacks, front or rear. See the description of item **PTT in CW as** in the manual section for **(CW) CW MENU** in Chapter 3 and **EXTERNAL CW OUTPUT PLUS CW KEYS OPERATION FROM PADDLES** in Chapter 4.



(17) PWR

This button is used for setting RF power output on ORION. Press the PWR button then turn the MULTI knob to adjust value from 1 to 100. The value set from 1 to 100 will roughly correspond to power output in watts but this will vary a few watts depending on band and load impedance.

The PWR button also interacts with the TUNE button (40) for key down power output for tuning an antenna tuner or linear amplifier. See the description of TUNE (button 40) later in this section.

If the low level drive transverter output has been activated in the menu system, a low level output RF output level of approximately +15 dBm will be sent through the XVRT RF jack. This output power value is adjustable from +5 to +15 dBm by using the PWR and MULTI control when the transverter output is activated in the menus.

(18) MON

ORION II is equipped with a transmit audio monitor to allow the operator to hear actual transmitted audio. TX EQ, speech processing, TX bandwidth, LF rolloff all have an effect on the sound of the transmitted SSB signal, and to properly adjust these controls for no distortion and desired sound, use the monitor.

Press the MON button. The volume of monitor level is expressed as a value from 1 to 100% of available. Monitor is available through either headphones or via the speaker.

The MON function is also usable in FSK mode for monitoring of transmitted tones.

(19) SP

SP has two different functions depending on which mode the operator has selected. In SSB modes, the SP control is used for speech processing. In LSB or USB mode, press the SP button to turn the speech processor on and off. When on, use the MULTI knob to adjust from a value of 1 to 9. Higher values represent more processing. Please note on the highest settings of 8 and 9 that it is relatively easy to send the radio into SSB transmit distortion depending on where the mic gain and other TX controls are set! Use the monitor function to listen to your transmitted audio.

The SP button is used for keyer speed control in CW modes. Press the SP button when in LCW or UCW mode to activate the CW keyer. Speed control is 10 to 50 WPM.

(20) SEND FUNCTIONS

ORION II is equipped with three CW memories and three voice memories. ORION II will retain three on each mode, for a total of six. An asterisk (*) appears on the ORION II screen just to the right of each button when a SEND memory has been recorded.

To record a message in a voice mode in SEND 1 or SEND 2: Press and hold the appropriate button. A submenu titled DIGITAL VOICE RECORDER CONTROL will appear at the bottom of the screen.

There are five options: EXIT, RECORD, PLAY, DELETE and SAVE. The five buttons below these options (numbers 22 through 26) are used for these functions. To RECORD a message, depress the PTT button on your microphone. (You will not be transmitting on the air when the DIGITAL VOICE RECORDER CONTROL menu is shown on screen). Press RECORD (button 23) and begin speaking into the microphone. There are 4.54 seconds of available recording time for each of the SEND 1 and SEND 2 voice memories. When RECORD is pressed, the legend on the screen above the button changes to read STOP.

When you are finished recording the message, press the button again to STOP.

When finished, you can check the recording off the air by pressing PLAY (button **24**). To delete the recording, press DELETE (button **25**).

To retain the memory after the transceiver is powered off, press SAVE (button **26**). A message titled SAVING RECORDING will appear on the ORION II screen for several seconds during the save process.

To exit the voice recorder control menu, press EXIT (button **22**). Don't forget before pressing EXIT to release the PTT button on your microphone that you depressed earlier to record the message, or upon exiting your mic will be live.

To play your message while on the air, momentarily push the appropriate SEND button and your recording will be transmitted.

To record a message in a voice mode in SEND 3: Follow the same instructions as for SEND 1 or SEND 2. SEND 3's message can be up to 28.1 seconds in length but **cannot** be retained in memory by using the SAVE button after recording. This memory will erase after the transceiver is powered off.

To record a message in CW mode in SEND 1, SEND 2, or SEND 3: Press and hold the appropriate button. A submenu titled CW MEMORY KEYS CONTROL will appear at the bottom of the screen.

Please note: CW memories can only be recorded using the internal keyer.

There are four options: EXIT, RECORD, PLAY, and DELETE. The four buttons below these options (numbers **22** through **25**) are used for these functions. Unlike voice memories, all 3 CW memories are automatically saved to memory when recorded and will retain after powering off the transceiver.

To record a message in CW mode, press RECORD (button **23**) and begin sending CW. The words EXIT, RECORD, PLAY, and DELETE will momentarily disappear

and the word STOP will appear above button **23**. When you have completed your recording press button **23** to end (STOP). To check your CW memory off the air without transmitting, press PLAY (button **24**). To delete the CW memory, press DELETE (button **25**). To exit the CW memory keyer control menu, press EXIT (button **22**).

When playing your CW message on the air using SEND 1, SEND 2 or SEND 3, the CW keyer must be turned on. If off, the SEND buttons will not respond.

(21) USER 1 AND USER 2

ORION II is equipped with a total of five user profiles. User profiles are like a "super memory" – everything on the radio, all settings, all menu selections, everything will be saved to a user profile memory. Unlike traditional memories that save frequency, mode, bandwidth and maybe one or two other parameters.

The USER 1 and USER 2 buttons allow saving and recalling of user profile #1 and user profile #2. User profiles #3, #4 and default (#5) are accessible by pressing the RECALL button (**22**).

To save a user profile in either USER 1 or USER 2: Press and hold the desired button for two seconds. Two messages will appear on the screen: STORING PARAMETER SET and then STORE COMPLETE.

To recall user profile #1 or #2, momentarily press and release the USER 1 or USER 2 buttons. A series of messages will appear on the screen while ORION recalls stored information: RECALLING PARAMETER SET, RESTORING USER MENU SET, RESTORING RADIO STATE, and RECALL COMPLETE.

(22) RECALL

The RECALL button has two different functions. One is to allow recall of saved memories that have been entered using the 200 available "traditional" memories. The other function is to allow the operator to quickly recall the factory defaults for

ORION II or to select one of the four programmable user profiles.

To use RECALL to bring up either the factory default settings or a stored user profile, press and hold the RECALL button for two seconds. A submenu will appear, titled FACTORY DEFAULTS and two options EXIT (using button **22**) and RECALL (using button **24**) will appear at the bottom of the screen. The operator can scroll among the factory defaults and the four user profiles by turning the MULTI knob located to the upper right of the screen. When turned, the submenu display will change to read PARAMETER BACKUP #1, #2.....etc. The options of EXIT, STORE, and RECALL are given.

Factory defaults will return the radio to the state as after doing a master reset.

Note that PARAMETER BACKUP #1 and PARAMETER BACKUP #2 are duplicates of the user profiles that can be saved and recalled by using the USER 1 and USER 2 buttons. #3 and #4 and factory defaults are only accessible via this RECALL submenu.

RECALL is also used for recalling the traditional memories saved using the VFO A>M and VFO B>M buttons. To access the recall of memories, momentarily press and release the RECALL button. A submenu titled MEMORY RECALL will appear.

Stored memories can be examined using the MULTI knob. Turn the MULTI knob to see all stored memories with frequency and mode information.

Four options are shown under the memory locations: EXIT, M>VFO A, M>VFO B, and DELETE. Each of these functions uses buttons **22** through **25**, directly under the options shown on the screen.

To recall a stored memory to VFO A, press M>VFO A (button **23**). To recall a stored memory to VFO B, press M>VFO B (button **24**). To delete a stored memory, press DELETE (button **25**). To exit the memory recall submenu, press EXIT (button **22**).

(23) NB

The ORION II is equipped with a DSP noise blanker that is independently adjustable for each receiver.

To adjust the DSP noise blanker, press NB (button **23**). A value of 1 through 9 will appear on the screen just above the NB button. Use the MULTI knob to adjust the noise blanker value from 1 to 9. A higher value indicates more aggressive noise blanker action – please note that high noise blanker settings on loud SSB signals can lead to intermodulation distortion of received signals.

The DSP noise blanker is adjustable independently for each receiver, depending on which is selected for control by the MAIN RX and SUB RX buttons located between the two large main tuning knobs. See description later in this chapter of **(55) SUB RX** and **(56) MAIN RX** for information on these buttons and their functions.

Separate from the DSP NB, the main receiver only has a hardware noise blanker available. See the description of the hardware noise blanker in chapter 3 under **(RX) RX MENU**. This main receiver hardware noise blanker can be used together with or separate from the DSP NB.

The hardware NB can be turned on and off from the front panel by pressing and holding the NB button for two seconds. It also can be turned on or off through the menu system. When the hardware noise blanker is activated on the main receiver, an annunciator marked **:H** will appear next to the software noise blanker value on the screen.

(24) NR

ORION II is equipped with DSP noise reduction that is independently adjustable for each receiver.

There are nine different settings, and each of the nine are used to determine how aggressively (quickly) the NR adapts and identifies what is signal and what is noise.

Once the noise reduction value has been set for a given signal, no further adjustment of the noise reduction control is needed. Turning the NR to a higher value adjusts only how fast it adapts to a given signal vs. noise situation.

The DSP noise reduction is adjustable independently for each receiver, depending on which is selected for control by the MAIN RX and SUB RX buttons located between the two large main tuning knobs. See **(55) MAIN RX** and **(56) SUB RX** for information on these buttons and their function.

Refer to the section of Chapter 4 titled “**Optimal Uses of ORION II Receiver for Weak-Signal DXing and Contesting**” for more information on using DSP NR in weak signal environments.

(25) NOTCH

ORION II is equipped with a manual notch filter at the IF level. Press the NOTCH button to activate.

Both the center frequency of the notch and the width of the notch filter are user-adjustable.

When pressing the notch button, the center frequency value with the **C**: annunciator will appear. Example C: 500Hz would be a 500 Hz center frequency. The center frequency is variable from 20 to 4080 Hz in 10, 50, or 100 Hz steps (adjustable in the menu using the PBT/BW step size control).

While the C: value is shown, press the NOTCH button again to change the display to notch filter width. An annunciator marked **W**: with the notch width value will be shown. Example: W: 250Hz is a notch filter width of 250 Hz. Turn the MULTI knob to adjust the width value.

Pressing the NOTCH button when the W: value is shown will turn off the notch filter.

(26) AN

ORION II is equipped with an automatic notch filter for notching out carriers in voice

modes. Multiple carriers will be notched by the automatic filter.

To activate, press the AN button. Higher values indicate more aggressive action by the autonotch for suppressing undesired carriers.

(27) MODE

Pushing the MODE button allows selection of the various operating modes for the transceiver. Press the MODE button to bring up the mode selection menu.

Along the right side of the screen in descending order will be the available mode selections. Each mode selection will correspond to one of the buttons numbered **28** through **34** in Figure 2-1 at the beginning of Chapter 2. Example: to select USB, press MODE then press button **34** (labeled ATTN) to select USB.

Available modes are USB, LSB, UCW, LCW, AM, FM, and FSK. UCW and LCW are conventional CW modes, except the operator chooses whether the BFO is above or below the target frequency to minimize QRM (UCW is CW on the upper sideband, LCW is CW on the lower sideband).

When selecting a mode, the last bandwidth filter selected for that mode will be automatically recalled for use. USB, LSB, LCW, and UCW are all counted as separate modes for filter recall – a filter last used in USB will not be recalled or retained when switching the ORION II to LSB.

(28) PREAMP

The ORION II main receiver is equipped with a 12 dB gain preamp. Push the PREAMP button to activate. This button has no effect on the subreceiver; a built in always-on preamp is used for it.

(29) RF GAIN

The RFGAIN control is selectable independently for each receiver. Press RFGAIN and adjust the MULTI knob for a value between 0 and 100%. RF gain is used to limit receiver sensitivity to minimize

extraneous noise under large-signal conditions.

Selecting RF GAIN and turning value down using the MULTI knob will limit overall receiver sensitivity for both the analog and DSP receiver stages.

DSP receiver gain alone can be limited via the menu system by the use of the threshold function in programmable AGC, if desired. See the section in Chapter 4 of this manual titled “**Optimal Uses of ORION Receiver for Weak-Signal DXing and Contesting**” and the description of **(RX) RX MENU** elsewhere in this manual.

(30) SPOT

ORION II is equipped with adjustable CW sidetone and autotracking CW offset. This value can be adjusted in the menu system or via the front panel.

Pressing and holding the SPOT button will produce a tone at the value set by the operator (default is 700 Hz). This tone can be matched to the received tone of an on-air CW signal to achieve zero beat. Press and hold the SPOT button while tuning in a CW signal. When the tones match, you are on the proper frequency.

The SPOT value can be adjusted by pressing and holding the SPOT button while turning the MULTI knob. It is adjustable from 300 to 1200 Hz. This value is also adjustable via the menu system. See the description for **(CW) CW MENU** in Chapter 3.

(31) STEP

The tuning step size for each receiver is adjustable in seven different steps, 1, 10, 100 Hz and 1, 5, 10, and 100 kHz.

Press STEP. A submenu with the seven values will appear, use buttons **28** through **34** to select a particular value. STEP size is adjusted per receiver depending on which of the MAIN RX or SUB RX buttons located between the two main tuning knob is lit. There is also a quick step size jump feature accessible by pressing a lit MAIN RX or

SUB RX button (see **(55) MAIN RX** and **(56) SUB RX**).

(32) SWEEP

The main receiver on the ORION II is equipped with a real-time band sweep display. A separate adjustment in the menus allows for the sweep range to be adjusted in five different increments; the default is 72 kHz. See the description in Chapter 3 under **(RX) RX MENU**.

Press the SWEEP button. A display of activity will appear at the bottom of the screen, updating several times per second. The center of the sweep scope has “0” above it to indicate kHz offset from center where a signal appears. The other numbers appearing at the top of the sweep scope to the left and right of the “0” are the distance in kHz from the dial frequency.

To tune to a signal seen on the spectrum scope, turn the main tuning knob on the main receiver towards the signal seen on the scope. If the signal is to the left on the screen, turn the knob counterclockwise (downward in frequency). If the signal is shown to the right, turn the knob clockwise (upward in frequency).

(33) AGC

ORION II has five selectable AGC settings that can be used independently on each receiver. The available options are OFF, SLOW, MED, FAST, and PROG.

To select AGC setting, press the AGC button to cycle through the available choices.

AGC settings of SLOW, MEDIUM, FAST, and PROGRAMMABLE have a number of parameters that are user adjustable to place AGC action exactly where the operator desires. See the description in chapter 3 under **(RX) RX MENU** for detail.

(34) ATTN

ORION II is equipped with a receive attenuator that can be selected independently for each receiver. There are

four selectable steps of (off) or 6 dB, 12 dB and 18 dB of attenuation. To activate, press the ATTN button. Pressing the ATTN button will cycle through the four available settings (OFF, 6 dB, 12 dB, 18 dB) and an annunciator on the screen next to the ATTN button will indicate the value selected.

(35) MENUS

ORION II has a number of user adjustable settings that allow the operator to customize preferences for their particular style of operating. Several menus are present in ORION II to facilitate this. To access them, press and release the MENUS button.

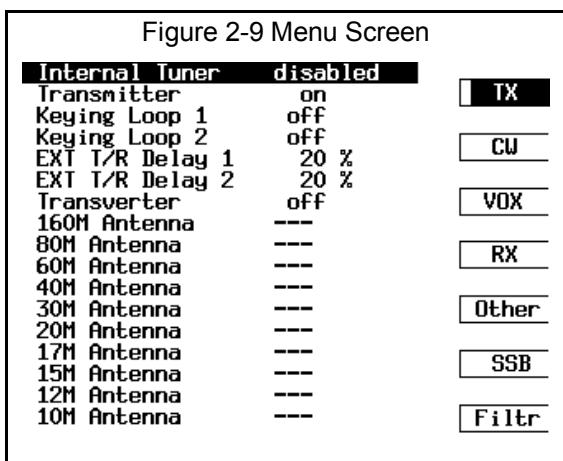

Figure 2-9 shows the menu screen. There are seven selectable menus. To the right side of the screen, there are seven choices. They are: TX, CW, VOX, RX, Other, SSB, Filtr. Each of these menus can be accessed by pressing the corresponding button (28 through 34) next to the right edge of the screen. In Figure 2-9, button 34 was pressed to access the TX menu. The TX annunciator on the screen is highlighted and the menu options for TX are shown on the screen. All seven of the menus are explained in detail in Chapter 3 of this manual.

To exit the menus and go back to normal transceiver operation, press the MENUS button again.

The MENUS button can also be used to display the currently installed firmware version in the transceiver. Push and hold

the MENUS button for two seconds. The words TEN-TEC ORION II, the Ten-Tec logo, and the firmware version number will momentarily appear on the screen.

(36) AUDIO

ORION II has two audio sources (main receiver and sub receiver) and each has four potential destinations (SPEAKER, LEFT, RIGHT, or BOTH phones) that the operator selects. The separate volume controls (knobs MAIN AF and SUB AF) let the operator adjust the audio mix to the headphones or speaker.

To access the audio menu, press the AUDIO button.

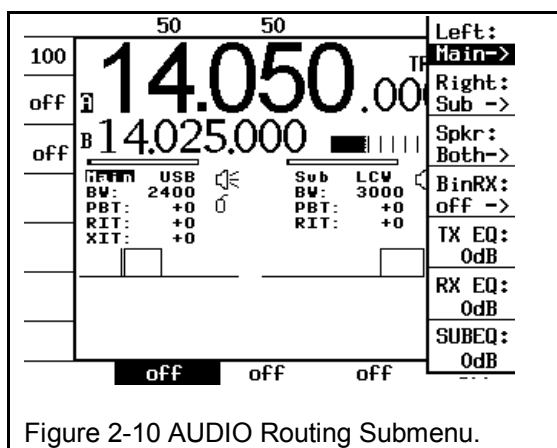

Figure 2-10 AUDIO Routing Submenu.

See Figure 2-10. Each selectable item uses buttons 28 through 34 for selection.

“Left:” – is for routing audio to the left side of stereo headphones. The available choices are Main (main receiver audio), Sub (sub receiver audio), and Both (main and sub receiver audio). Press button 28 to select as desired. “Right:” is for the right side of stereo headphones. “Spkr:” is for internal and external speaker audio.

If using mono headphones wired with a stereo connector as described in the description for the phones jack (see button 15 description earlier in the manual) – use the “Left:” headphone setting to determine what audio is heard in your headphones. We recommend stereo headphones for using ORION II to its fullest effect.

“**BinRX:**” is the unique binaural Panoramic Stereo™ receive feature incorporated in ORION II. High-pass and low-pass filtering, combined with time delays, produce a three-dimensional spatial sound from a monaural audio source.

Panoramic Stereo™ can be used for the CW operator to automatically zero beat received CW signals by listening in stereo. If the signal is too high or too low for the CW offset that the operator has selected, the signal will be heard to the left or to the right with stereo headphones. Tuning in the signal for equal audio in both ears tells the operator that the signal is zero beat and on the correct frequency.

The CW offset you have selected using the SPOT function (see explanation for button **30** above) controls at what frequency the received CW signal is centered in your stereo headphones.

Additionally, on CW, spatial dispersion makes it easier to pick out one signal among many. During a CW pileup, the operator can more easily and quickly pick out single call signs from a number of callers than with mono receive audio.

Panoramic Stereo™ receive also is usable in SSB modes with the same effect. Signals below or above in frequency will be heard in one side or the other of stereo headphones and when centered assure the operator they are on frequency.

When selecting “**BinRX:**” on the menu, you will notice that the headphone settings for “**Left:**” and “**Right:**” will also change to whichever receiver you have selected Panoramic Stereo receive for. When “**BinRX:**” is set to off, “**Left:**” and “**Right:**” will revert to earlier values set by the operator.

ORION II also provides audio equalization for both receivers and for the transmitter. They enable tailoring audio frequency response for greater effectiveness and to accommodate your preferences.

The TX EQ (transmit equalizer) establishes a specific audio profile for your transmitted

audio from either the MIC or AUX audio input sources. The TX EQ is selectable in 1-dB steps from high pitched at –20 to essentially flat response at 0 dB to very bassy at +20 dB. Press button **30** and turn the MULTI knob to adjust values upward or downward. TX EQ can also be adjusted upwards in 1 dB increments by pushing button **30**. The MULTI knob can adjust the values up or down.

RX EQ (main receiver equalization) works the same way. More treble or bass response from main receiver audio can be had by adjusting this selection with button **29** and the MULTI knob.

SUBEQ (subreceiver equalization) is identical in operation to RX EQ, except it is used for sub receiver audio. Press button **28** and use the MULTI knob to adjust.

The graphs in Figures 2-11, 2-12 and 2-13 show the response curves in the center and at the extremes of the equalization controls. Lower numbers of decibels indicate a gentler slope.

The same curves apply to both receiver equalizers and to the transmitter equalizer. The displayed setting of the equalizers refers to the amplitude in dB (at about 100 Hz) relative to the highest frequency in the passband. For example, the –20 dB setting produces –20 dB at 100 Hz relative to 0 dB at 6 kHz.

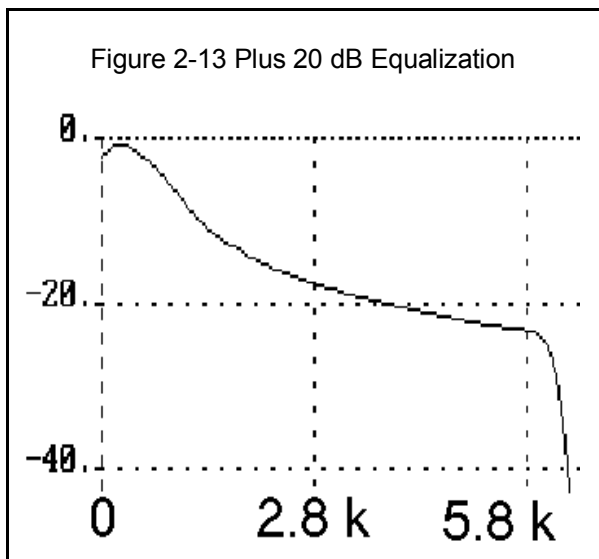
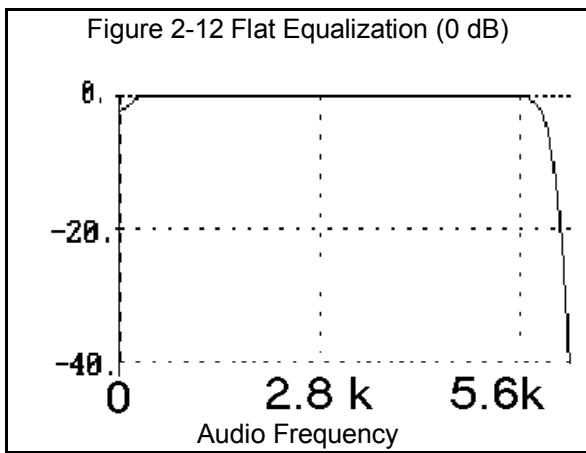
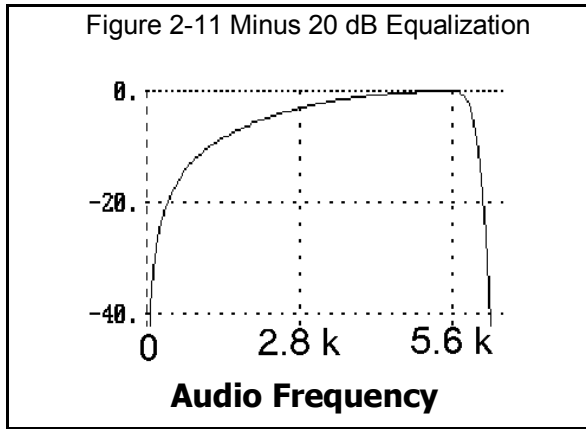

Please note that there are several factors that interact for ORION II SSB transmit audio. Type of microphone, sound of the operators voice, distance from the microphone, the TX EQ settings and the TX filter BW and LF rolloff settings as selected in the SSB menu. See the section of Chapter 4 titled **FACTORS THAT AFFECT THE SOUND OF SSB TRANSMIT AUDIO AND THEIR ADJUSTMENT** for a description in more detail how to most optimally adjust ORION II SSB transmit audio. This section of Chapter 4 also includes a chart with some suggested settings to get you started.

(37) VOX

Used for turning VOX operation on and off for transmit on voice modes. VOX trip, anti-VOX, and VOX hang settings are adjusted through the menu system. When the VOX button is pressed, the annunciator “on” will appear on the screen just below the button. If no “on” annunciator is shown, VOX operation is disabled.

(38) S-TONE

Sidetone volume for CW operation. Press the S-TONE button. Directly under the screen a value of 0 (off) to 100 will appear. Use the MULTI knob to change the value. Both the transmitted CW sidetone volume and the volume from using the SPOT function are affected by this setting.

(39) MIC

The MIC control is used for setting microphone gain in SSB modes. Press the MIC button, and then use the MULTI knob to set the desired value.

To set the proper level, adjust mic gain upward until the red ALC LED (located just to the left of the S-meter) is flashing. You may also employ the use of the monitor function (see **(18) MON**) to properly adjust the sound of transmitted audio.

(40) TUNE

The TUNE button, when pressed, will transmit a CW carrier at approximately 20 watts output power to allow either the internal automatic antenna tuner to tune (if installed) or for user adjustment of an external antenna tuner or linear amplifier.

It may be desirable to have keydown CW carrier output at the power output level set by using the PWR control (button **17**). To do so, press the PWR button immediately after pushing the TUNE button. Power output will move from the low power setting to whatever level the PWR control has been set at with the MULTI knob. Repeat operation will require pushing TUNE then PWR again for the higher output value.

ALC

The ALC light just to the left of the S-meter is used to indicate when automatic level control action for the set output of the radio has been reached. It will flash on and off with all CW characters transmitted. On SSB, the ALC light should light on voice peaks to indicate proper adjustment of microphone gain.

At very low power outputs, the ALC light will be lit continuously when transmitting in SSB modes. This is normal.

BARGRAPH

A bargraph meter appears on the ORION screen immediately to the right of the VFO B frequency display. This un-scaled meter is used as a signal strength reference for the subreceiver, but no s-unit value is indicated. Additionally, appearing above the bargraph is a display of SWR while transmitting. The SWR display is also used to display the legend **tuned** after use of the internal automatic antenna tuner (if installed).

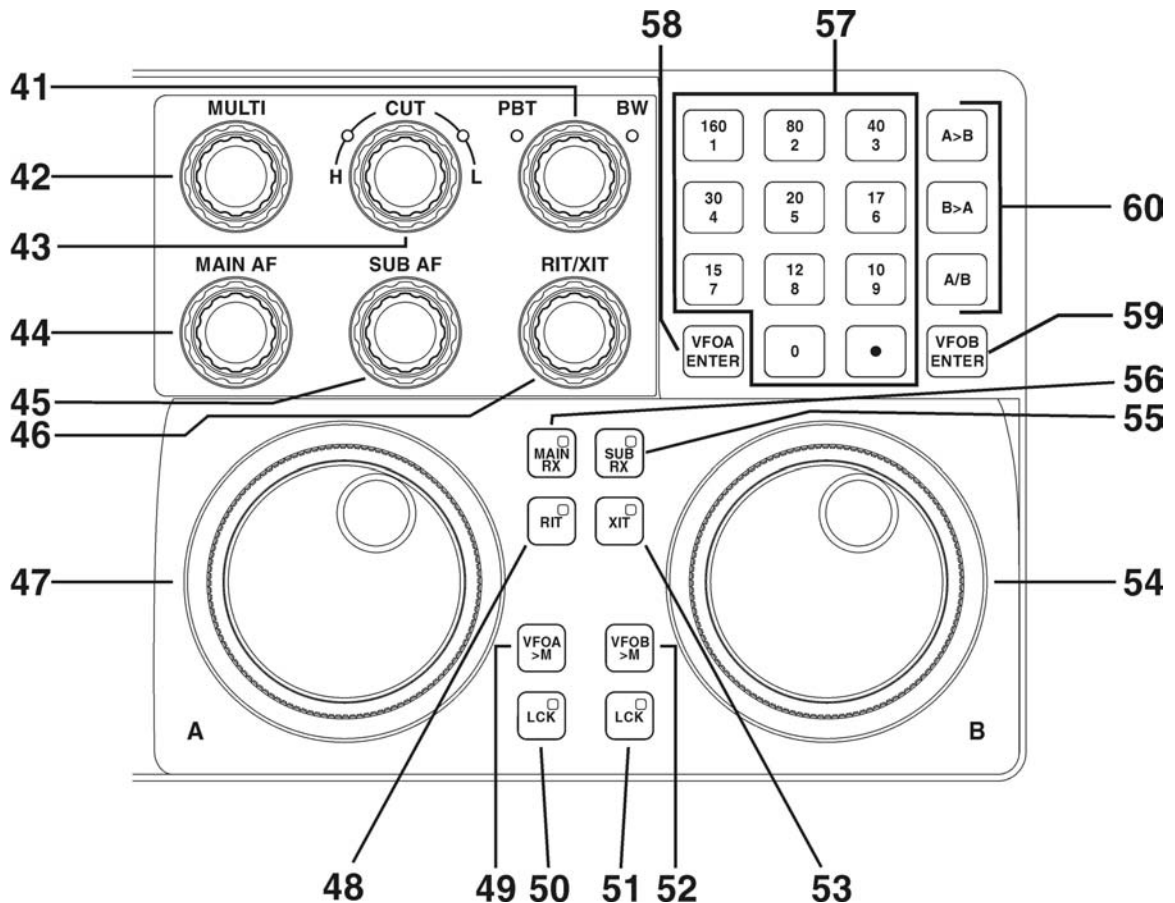

Please read the section describing the functions of buttons 55 (SUB RX) and 56 (MAIN RX) before proceeding with the instructions for other controls.

(41) PBT/BW ENCODER

Receiver bandwidth (BW) and passband tuning (PBT) are adjustable using this encoder.

DSP bandwidth and passband tuning are selectable independently on each receiver depending on the status of buttons 55 and 56.

To adjust BW or PBT value: A green LED indicator is next to the BW and PBT legends on the front of the radio above the encoder. Press the encoder to switch between BW and PBT. The BW and PBT values are shown per receiver on the screen. BW is adjustable from 100 to 6000 Hz. PBT is adjustable + or - 2.5 kHz from center. PBT

can easily be cleared to zero. When the PBT LED is lit next to the encoder, press the encoder in and hold for two seconds. The PBT value will revert to zero.

BW and PBT step size is adjustable in the menu system in 10, 50, and 100 Hz steps (10 Hz is the default setting). BW and PBT can also be set to track each other automatically on each receiver in the menu system. See the description of **RX MENU** in Chapter 3.

(42) MULTI ENCODER

The MULTI knob is used for control of a variety of transceiver values as assigned by buttons pressed by the operator.

(43) HI CUT - LO CUT

ORION II has a dual-function HI CUT / LO CUT control that modifies the BW function. HI CUT and LO CUT (referred to *audio* frequency) functions allow the operator to move *one edge of the filter* at a time towards or away from the center of the passband.

This can be especially useful for rejecting adjacent frequency interference. The HI / LO CUT control changes its function between HI CUT and LO CUT when the operator briefly pushes the knob toward the panel. LED indicators show which function the knob is performing at any time. The independent HI CUT and LO CUT settings each receiver appear on the screen – you will see the BW and PBT values scroll as the knob is turned. Pushing and holding in the HI CUT / LO CUT knob for two seconds will zero out the CUT setting.

See Figure 2-15 for examples of HI CUT and LO CUT operation.

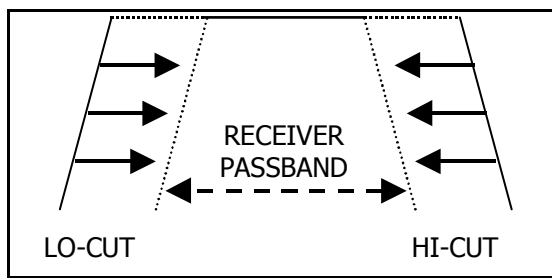

Figure 2-15 HI CUT and LO CUT effects on the passband.

(44) MAIN AF ENCODER

The MAIN AF encoder is used to control main receiver volume output through the speaker and headphones. Turn to adjust. There is a bargraph display on the screen that shows setting of MAIN AF, just above the BW, PBT, RIT, XIT values that are shown stacked on the left side of the screen.

The MAIN AF receiver gain can be muted by pushing the encoder. When muted, the top half of the bargraph display on the screen will disappear to tell the operator it is in mute. Turning or pushing in the encoder knob un-mutes and restores MAIN AF at the last value used before it was muted.

(45) SUB AF ENCODER

The SUB AF encoder is used to control sub receiver volume output through the speaker and headphones. Turn to adjust. There is a bargraph display on the screen that shows setting of MAIN AF, just above the BW, PBT, RIT, XIT values that are shown stacked on the left side of the screen.

The SUB AF receiver gain can be muted by pushing the encoder. When muted, the top

half of the bargraph display on the screen will disappear to tell the operator it is in mute. Turning or pushing in the encoder knob un-mutes and restores SUB AF at the last value used before it was muted.

(46) RIT/XIT ENCODER

RIT (receive incremental tuning) is available to be set independently on each receiver depending on which of buttons **55** and **56** are selected. Press the RIT button (**48**) to activate. Turn the RIT knob to adjust in the range of +/- 10 kHz.

XIT (transmit incremental tuning) is available on the transmitter, in the range of +/- 10 kHz. Press the XIT button (**53**) to activate and de-activate. An annunciator on the left side of the screen will indicate XIT value.

To quickly clear RIT and/or XIT, press the RIT/XIT encoder knob. Values will automatically be reset to zero.

(47) MAIN TUNING KNOB "A"

and (54) MAIN TUNING KNOB "B"

The large tuning knob closest to the screen is for operation of VFO A. The large tuning knob to the far right of the transceiver is for operation of VFO B.

(48) RIT and (53) XIT

The RIT and XIT buttons are for turning the RIT and XIT controls on and off. See the description of RIT and XIT operation listed under (46) above.

(49) and (52) VFO A>M and VFO B>M

The VFO A>M and VFO B>M buttons are used for storing frequencies on either VFO into the memory system.

To store a frequency from VFO A to memory, press VFO A>M. A submenu titled MEMORY STORE will appear at the bottom of the screen. Turn the MULTI knob to scroll through the available memory locations. There are 200 available memories.

At the bottom of the screen there are four choices available: EXIT, VFO A>M, VFO B>M, DELETE. Press one of the four buttons below the four choices to select.

VFO A>M stores the frequency and mode from VFO A to a selected memory channel. VFO B>M stores the frequency and mode from VFO B to a selected memory channel.

DELETE is to delete a stored memory with no other action taken. EXIT is to exit the MEMORY STORE submenu.

Note that pressing either VFO A>M or VFO B>M button allows the operator to actually store either VFO's information as a memory. This was done so if the operator accidentally pressed the VFO A>M button, when the intention was VFO B>M (and vice versa), the memory could still be stored as desired.

(50) and (51) LCK

The LCK buttons are to lock the main tuning knobs for VFO A and/or VFO B. Press the left hand LCK button **(50)** and the VFO A tuning knob to the left is locked. An amber LED will light inside the button indicating it is locked. Press the right hand LCK button **(51)** and the VFO B tuning knob to the left is locked. An amber LED will light inside the button indicating it is locked.

(52) VFO B>M

See description for button **49**.

(53) XIT

See description for button **48**.

(54) MAIN TUNING KNOB "B"

See description for knob **47**.

(55) SUB RX and (56) MAIN RX

Buttons **55** (SUB RX) and **56** (MAIN RX) control which receiver is accepting commands from the buttons surrounding the screen, and from the encoders above the main tuning knob. It also utilizes a hidden step size jump function ("xm") that will be explained further below.

Many receiver functions can be set independently for each receiver. The default condition is to have the MAIN RX **(56)** button lit. Try adjusting some of the receiver controls like RIT, RFGAIN, BW, AGC, ATTN. Now, press the SUB RX button **(55)**. Note that many of the settings for the items you have adjusted may change on the screen. That is because you are now seeing the settings for the sub receiver on the screen, and you are now ready to change values for subreceiver functions. To return to main receiver functions, press the MAIN RX button.

There is also a step size jump function accessible by pressing an already lit MAIN RX or SUB RX button.

When tuning up and down the band, it may be useful to be able to quickly jump up one step size without having to push the STEP button (see description for button **31**), go into the submenu, come out, tune, go back into the STEP submenu, and so forth.

To use the jump feature on the main receiver: If the MAIN RX button is already lit, press it again. The annunciator on the screen next to the STEP button will now move up to the next highest step size and the letters "xm" will appear above the shown step size. To de-select the "xm" feature, press the MAIN RX button again.

This feature is also available on the subreceiver by pressing an already lit SUB RX button.

(57) FREQUENCY ENTRY AND BAND CHANGE BUTTONS

ORION II is equipped with a band-change keypad that also is used for direct frequency entry and to access the four bandstacking registers.

To change bands, press the button that corresponds to the desired ham band. Note: Press the "0" button for 60 meters (5 MHz).

ORION II is equipped with four bandstacking registers per band that will retain frequency, mode, and receiver bandwidth. Example: Press the 20 button to put the radio on the 20 meter band. Repeated pressing of the 20 button will cycle through the four band stacking registers for 20 meters.

ORION II uses a default VFO for the band change keypad. Next to the frequency displays on the screen are "A" and "B" to the extreme left of the screen. One of the two will be highlighted in reverse text (default is VFO A). This indicates to the operator which VFO will accept band changes from the keypad. See description of the A/B button function **(60)**.

(58) VFO A ENTER

ORION II allows for direct frequency entry from the keypad for either VFO. To enter a frequency into VFO A, press VFO A ENTER and then use the keypad to enter a frequency. Use the decimal point button.

Example: To enter 7.160000 MHz, press VFO A ENTER, “7”, “.”, “1”, “6”, VFO A ENTER. When VFO A ENTER is pressed the second time during a direct frequency entry, the remaining digits will be filled with zeros. Note: If VFO A is assigned to the main receiver, and you try to enter a non-ham frequency, FREQUENCY NOT SUPPORTED will appear on the screen and you will be returned to the last frequency used before attempting the invalid direct entry.

(59) VFO B ENTER

Refer to instructions for **(58) VFO A ENTER**. VFO B ENTER works exactly the same, except the entered frequency will be for VFO B.

(60) A>B, B>A, A/B

Frequencies can quickly be copied or “flipped” between VFOs by pressing the A>B, B>A, or A/B buttons. A>B copies frequency information from VFO A to VFO B. B>A copies frequency information from VFO B to VFO A. A/B “flips” the two VFO’s frequency information; what was shown for A copies to B, what was shown for B copies to A.

Note that if trying to copy or flip a non-ham frequency to the main receiver that the radio will show an error message on the screen and revert to the last used frequencies before the invalid action was attempted.

If the main receiver is assigned to VFO A and the sub receiver is assigned to VFO B (or vice versa), mode and frequency information will also be copied between VFO’s when pressing A/B, A>B, B>A. If the receivers are both assigned to the same VFO, or either the main receiver or sub receiver are not assigned to a VFO, then only frequency information will be copied between the VFO’s. See **(8 – 13) VFO ASSIGNMENTS** elsewhere in the manual for a description of how receivers are assigned to VFO’s.

Additionally, the A/B button is used to change the default VFO for band changing with the keypad. Next to the two frequency displays at the extreme left of the screen are

the “A” and “B” annunciators. One of the two will be highlighted in reverse text to indicate it is the entry VFO for the band change keypad. To change, press and hold the A/B button for two seconds. Please note that the default is for VFO A, and powering off the transceiver will revert it to the default.

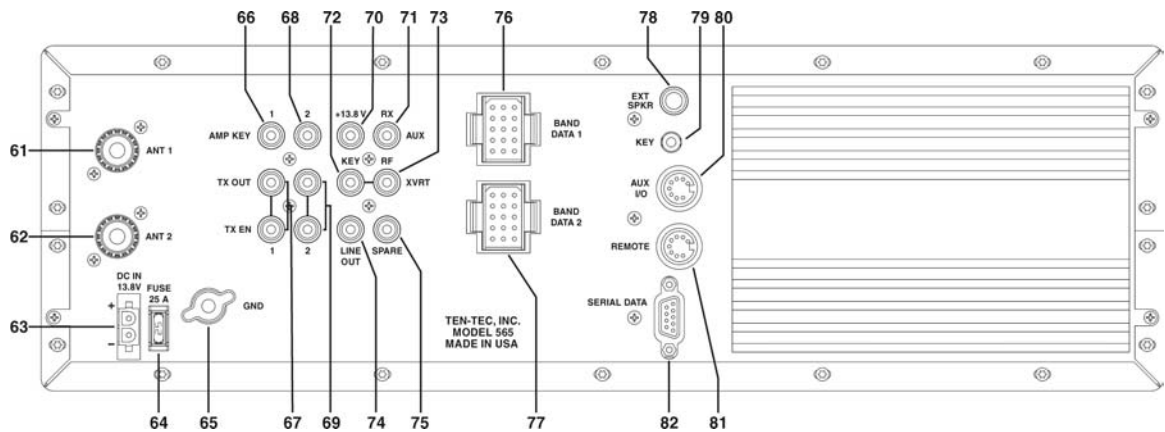

(61) ANT 1

ORION II is equipped with three antenna connectors; two for transceive, one for receive only. ANT 1 is for connection of a transceive antenna. Nominal impedance is 50 ohms. The optional automatic antenna tuner (if installed) uses the ANT 1 connector.

Connect a suitable antenna to this jack, fed with 50-ohm coaxial cable. This antenna is selected for use by the operator by pressing buttons on the front panel (see description of buttons 2 through 7 earlier in the manual).

Also see the descriptions for **(62) ANT 2** and **(71) AUX RX**.

(62) ANT 2

Like ANT 1, ANT 2 is a transceive antenna jack, with nominal impedance of 50 ohms.

The optional automatic antenna tuner (if installed) is not operable for an antenna connected to ANT 2.

Connect a suitable antenna to this jack, fed with 50 ohm coaxial cable. This antenna is selected for use by the operator by pressing buttons on the front panel (see description of buttons 2 through 7 earlier in the manual).

Also see the descriptions for **(61) ANT 1** and **(71) AUX RX**.

(63) DC IN

This is the dc input connector. ORION II requires 23 amps at +13.8 Vdc nominal for 100 watts output power. The supply voltage can range from +12.8 to +15.0 Vdc but +13.8 Vdc is the optimum value.

We recommend using the included dc power cable (P/N 86095). We have also included spare connector pins (P/N 41020) and a spare two-pin power connector shell (P/N 35165) for building your own cable. The power supply plug will attach in only one direction to the polarized two-pin dc connector on ORION's rear panel. Use no less than #14 gauge (#12 recommended) stranded wires for three-foot long connections to accommodate the high current demand during transmit. Use heavier gauge wire for longer power supply leads.

(64) FUSE 25 A

ORION II is equipped with a 25-ampere blade-type automotive fuse. A replacement has also been provided in the transceiver packing kit.

(65) GND

The GND wingnut is for connection of station ground or counterpoise. See **A WORD ABOUT GROUNDING** in Chapter 1.

(66) AMP KEY 1

ORION II is equipped with two sets of amplifier keying outputs to allow two linear amplifiers to be simultaneously connected to the transceiver. AMP KEY 1 (and TX OUT 1 / TX EN 1, described next) utilize the ANT 1 antenna connector for interfacing to an amp.

AMP KEY 1 is typically used as a non-QSK keying connection for a linear amplifier. However, it is acceptable to connect QSK linear amplifiers that do not employ a full break-in keying loop to this jack as well. AMP KEY 1 (and AMP KEY 2) are open collector outputs. RF appears approximately 15 mS after AMP KEY contacts close.

An adjustable delay (called **EXT T/R Delay 1**) gives the operator the ability to keep the amplifier keyed longer, preventing drop outs between words of SSB or CW operation.

EXT T/R Delay 1 is found in the TX submenu under MENUS.

The external amplifier key line should not apply more than +100V (output inactive) nor should it draw more than 250 mA (output active). Many older linear amplifiers like those manufactured by Collins, Drake, and Heathkit have a higher voltage on the keyline. Such amplifiers require a relay or transistor switch between the ORION II AMP KEY 1 jack and the amplifier keyline. If you are unsure if your amplifier is suitable, please consult the operator's manual for your amplifier or contact the Ten-Tec service department. See Chapter 4 for a complete description on interfacing a linear to the ORION II.

(67) TX OUT 1 / TX EN 1

Many QSK linear amplifiers are equipped with a full break-in keying loop to assure proper sequencing of amplifier keying when operating full break-in CW. TX OUT 1 and TX EN 1 are used for a full break-in linear amp using ANT 1.

TX OUT and TX EN should be connected to the corresponding QSK loop IN and OUT jacks on your amp. On a Ten-Tec QSK amp, TX OUT is connected to KEY IN and TX EN is connected to KEY OUT via shielded cables (consult the operator's manual of your non-Ten-Tec QSK amp for the proper loop information).

To use the full break-in keying loop, it must be enabled from the MENUS. The keying loop is turned on and off via the TX submenu in the MENUS (see the **TX MENU** description in Chapter 3). Note: If the loop is turned on, and no connections are made it will prevent the ORION II from transmitting.

See Chapter 4 for a complete description on interfacing a linear to the ORION II.

TX EN can also act as a transmit inhibit input if it is desirable to prevent ORION II from transmitting until other station accessories have been switched. Example: The last item keyed from a sequencer used for VHF transverter operation. To use the loop in this manner, turn the keying loop on in the MENUS. Connect inhibit line to the TX EN jack. The ORION will not transmit until a closure to ground appears at the TX EN jack.

(68) AMP KEY 2

AMP KEY 2 is for connection of a second linear amplifier to be used with the ANT 2 antenna connector.

AMP KEY 2 is typically used as a non-QSK keying connection for a linear amplifier. However, it is acceptable to connect QSK linear amplifiers that do not employ a full break-in keying loop to this jack as well. AMP KEY 2 (and AMP KEY 1) are open collector outputs.

An adjustable delay (called **EXT T/R Delay 2**) gives the operator the ability to keep the amplifier keyed longer, preventing drop outs between words of SSB or CW operation.

EXT T/R Delay 2 is found in the TX submenu under MENUS.

The external amplifier keyline voltage warning as described for AMP KEY 1 also applies to AMP KEY 2. See (66).

See Chapter 4 for a complete description on interfacing a linear to the ORION II.

(69) TX OUT 2 / TX EN 2

TX OUT 2 and TX EN 2 are used for a full break-in linear amp using ANT 2.

TX OUT and TX EN should be connected to the corresponding QSK loop IN and OUT jacks on your amp. On a Ten-Tec QSK amp, TX OUT is connected to KEY IN and TX EN is connected to KEY OUT via

shielded cables (consult the operator's manual of your non-Ten-Tec QSK amp for the proper loop information).

To use the full break-in keying loop, it must be enabled from the MENUS. The keying loop is turned on and off via the TX submenu in the MENUS. Note: If the loop is turned on, and no connections are made it will prevent the ORION II from transmitting.

See Chapter 4 for a complete description on interfacing a linear to the ORION II.

TX EN can also act as a transmit inhibit input if it is desirable to prevent ORION II from transmitting until other station accessories have been switched. Example: The last item keyed from a sequencer used for VHF transverter operation. To use the loop in this manner, turn the keying loop on in the MENUS. Connect the inhibit line to the TX EN jack. The ORION II will not transmit until a closure to ground appears at the TX EN jack.

(70) +13.8 VDC

This jack provides +13.8 Vdc for connection of accessory equipment. A maximum of 2 amps current draw is possible. The jack is equipped with a thermal shut-off, autoreset 2 ampere fuse. The jack has voltage present only when transceiver power is turned on.

(71) AUX RX

This RCA-style phono connector is for connection of a receive only antenna. This antenna can be used to transceive with either ANT 1 or ANT 2 being used as the transmit antenna, merely by selecting the appropriate button on the front panel (see description of buttons 2 through 7 on the front of the radio).

(72) XVRT KEY and (73) XVTR RF

XVRT KEY is transmit keyline for external transverter. Connect this jack to the keyline of your transverter unit. The capabilities and precautions for this circuit are the same as for the AMP 1 KEY circuit described above.

XVTR RF provides a low-level TX RF output for external transverter. The RF output level is ALC-controlled at approximately +15 dBm - this is adjustable from +5 to +15 dBm by using the PWR and MULTI control when the transverter output has been activated in the

MENUS. Both transverter support connections are activated via the TX menu.

See Chapter 4 for complete information and diagrams on connecting a VHF or UHF transverter to ORION II.

(74) LINE OUT

This is a line level output. What is present at this jack is determined by the **Line Out Source** item in the Other: menu. Line level audio from the main, sub, or both receivers can be routed via this jack. There are three selectable output level of High, Med, Low that are selected in the Other: menu under line item **Line Out Level**. 'High' is approximately 1 V p-p output, 'Med' is approximately .5 V p-p output, 'Low' is approximately .25 V p-p output. Impedance 600 ohms. 1 V p-p at 600 ohms (the 'High' setting) is typically the line level utilized by most equipment requiring a line level input signal. Please note there are also fixed 1 V p-p 600 ohm line level outputs for main and sub receiver audio, as determined by the AUDIO menu available on the AUX I/O connector on the rear panel.

(75) SPARE

This is an open jack provided for future use or for custom modifications made by the user.

(76) BAND DATA 1 and

(77) BAND DATA 2

These are 15-pin receptacles used for switching accessory devices. BAND DATA 1 corresponds to ANT 1 and AMP KEY 1 or TX OUT / TX EN 1. BAND DATA 2 corresponds to ANT 2 and AMP KEY 2 or TX OUT / TX EN 2. They contain open-collector active-low lines for 5 to 13-volt control of amplifiers and other devices to be switched by amateur band selection. The external load should not apply more than +13.8V (output inactive) nor should it draw more than 250 mA (output active).

BAND DATA 1 and BAND DATA 2 outputs are controlled by the ORION II transmit frequency.

Figure 2-17 Band Data Connector Pin-Outs

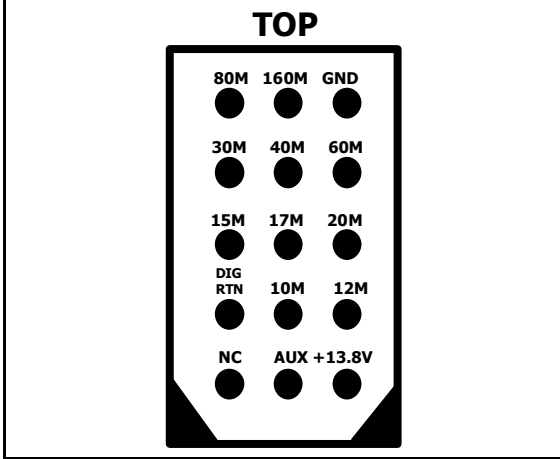

Figure 2-18 below is a sample example of controlling a relay from the individual pins.

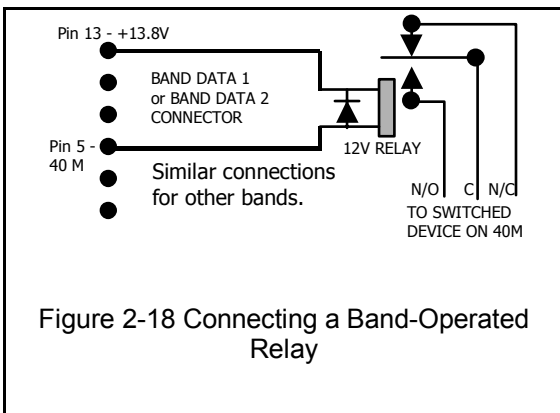

Figure 2-18 Connecting a Band-Operated Relay

(78) EXT SPKR

This jack is for connection of an external speaker. When connected using a standard 1/4" phone plug, the internal speaker in ORION II is disabled. Tip of the 1/4" phone plug is audio, sleeve is ground. Requirements for an external speaker connected to ORION II is minimum 4 watts power handling, 4 ohms minimum impedance load.

(79) KEY

The rear panel key jack is wired in parallel with the front panel CW key jack (see description of (16) CW earlier in the manual for operation, wiring instructions and operation).

(80) AUX I/O

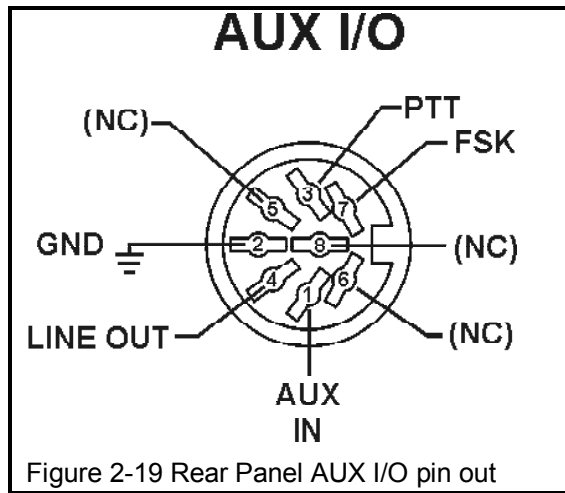

Figure 2-19 Rear Panel AUX I/O pin out

The AUX I/O jack is an 8-pin DIN receptacle used for interfacing accessory device requiring audio in/out connections, FSK connections and/or an auxiliary PTT input.

An 8-pin DIN connector (p/n 46172) and an accessory cable, (p/n 46176) have been provided as part of the ORION II packing kit for easier connection of the AUX I/O jack to accessory equipment. The cable is color-coded as follows: WHITE = pin 1, audio input. YELLOW = pin 4, line level audio output. RED = pin 5, no connection. BLACK = pin 3, push to talk. Ground from the 46176 cable is connected to pin 2.

Pin 1 is used for a line level audio input from an accessory device (like a TNC or sound card for digital mode operation). There is a gain control available for this input accessible through the menu system. See the description under **SSB MENU** in Chapter 3.

Pin 2 is ground.

Pin 3 is a PTT connection. In SSB and AM modes, when grounded, the radio begins transmitting. In CW modes, the behavior of the ORION II when pin 3 is closed to ground is dependent on the setting of the menu item **PTT in CW as in the CW MENU**. See the description of this item in Chapter 3.

This pin can be used for connection of a footswitch for SSB operation, or for accepting CW from an external keyer or computer generated output (like the CW keying output from popular contest logging

software), or for PTT control of the radio in CW modes.

Pin 4 is line level audio output. Which receiver(s) are output to here and the level of audio sent to the jack are controlled by the **Line Out Src** and **Line Out Level** commands in the **Other** menu.

Pin 5 and Pin 6 have no connection.

Pin 7 is the FSK mark/space input. 5 volts = 1 = mark, 0 volts = 0 = space. See **FSK OPERATION** section in Chapter 4.

Pin 8 has no connection.

(81) REMOTE

The REMOTE jack is used for connection of the model 302R accessory remote encoder/keypad, allowing armchair tuning and control of transceiver functions.

(82) SERIAL DATA

The serial data connector is used for both loading Flash-ROM updates into the transceiver and for computer control of radio. One of the great features about ORION is that the latest version of the radio is always available from our firmware update website.

Complete computer control of the ORION is possible via the SERIAL DATA connector.

A programmers reference guide and the latest version of the radio firmware are located on Ten-Tec's firmware update site at **www.rfsquared.com**

Brief instructions on firmware updating your transceiver are provided in Chapter 4.

Chapter 3 – MENU SYSTEM

ORION II is equipped with a series of menus, each clearly labeled, for various transceiver settings. Most often used functions are available on the transceiver front panel via buttons and knobs. Menus are used for items for which only an occasional or one-time adjustment is needed.

To access the MENU system, press the MENUS button located to the upper right hand corner of the radio screen.

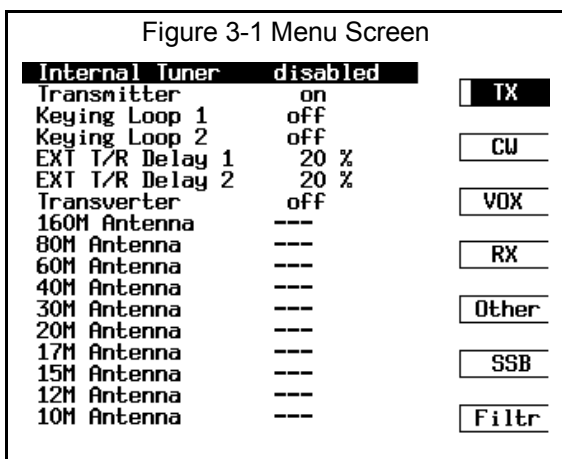

A menu screen, as shown above in Figure 3-1 will appear.

There are seven selectable menus accessible after pressing the MENUS button. To the right side of the screen, there are seven choices: TX, CW, VOX, RX, Other, SSB, Filtr. Each of these menus can be accessed by pressing the corresponding button next to the right edge of the screen. In Figure 3-1, a button was pressed to access the TX menu. The TX annunciator on the screen is highlighted and the menu options for TX are shown in text on the screen.

In each menu, to scroll through the available choices on the screen, turn the large main tuning knob (“VFO A”) closest to the radio screen. For each line item, to change the values, turn the MULTI knob. To exit the menu system and return to radio operation, press the MENUS button again.

(TX) TX MENU

The TX menu is used for controls related to the ORION II transmitter. They are described line-by-line below.

Internal Tuner refers to the optional internal automatic antenna tuner in ORION II. If installed, the tuner can be enabled or disabled with this line item. The internal tuner is operable on the ANT 1 connection only.

The internal tuner, when enabled, is actuated by RF. When changing bands, the tuner has no memory feature and will have to be re-tuned using the TUNE button. See description of **(40) TUNE** in Chapter 2.

Transmitter allows the ORION II transmitter to be disabled. Use the MULTI knob to set to on or off.

Keying Loop 1 is used to enable the TX OUT 1 / TX EN 1 QSK keying loop as described in chapter 2 under **(67) TX OUT 1 / TX EN 1**. Note: If the loop is turned on and no connections are made it will prevent the ORION II from transmitting.

Keying Loop 2 is used to enable the TX OUT 2 / TX EN 2 QSK keying loop as described in chapter 2 under **(69) TX OUT / TX EN 2**. Note: If the loop is turned on and no connections are made it will prevent the ORION II from transmitting.

EXT T/R Delay 1 provides “hang time” for a non-QSK linear amplifier that has been connected to the AMP KEY 1 jack on the rear of the ORION II. This will prevent the amp from dropping out between words of a CW or SSB transmission. Also see the description of **(66) AMP KEY 1** in chapter 2.

EXT T/R Delay 2 provides “hang time” for a non-QSK linear amplifier that has been connected to the AMP KEY 2 jack on the rear of the ORION II. This will prevent the amp from dropping out between words of a CW or SSB transmission. Also see the description of **(68) AMP KEY 2** in chapter 2.

Transverter enables low level RF output from the XVRT RF jack on the rear of the transceiver. When turned on, no RF at regular power output will be transmitted

through the ANT 1 or ANT 2 connectors. The XVRT KEY jack for keying of the transverter is also activated when this menu selection is turned to 'on'.

Also see the transverter connection and operation description in Chapter 4.

The next 10 line items correspond to automatic antenna selection per band. ORION II provides the ability for the radio to automatically select an antenna combination when the band change keypad is used to change amateur bands.

The available options are **Ant1**, **Ant2**, **Ant1/RX**, **Ant2/RX** and ---. The --- dashed line represents "no change" and when changing to a band marked as such, the radio will retain the previous antenna selection before the band change was made.

Ant1 and **Ant2** automatically selects the antenna connected to ANT 1 or ANT 2 on the rear panel for transceive operation. **Ant1/RX** will select both the antenna connected to ANT 1 for transmit and the receive-only antenna connected to AUX RX for receive. **Ant2/RX** will select both the antenna connected to ANT 2 for transmit and the receive-only antenna connected to AUX RX for receive.

(CW) CW MENU

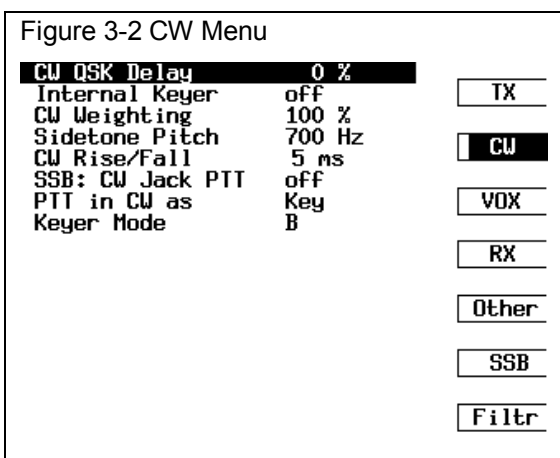

To select the CW menu, press the button immediately adjacent to the screen next to the CW selection (labeled AGC).

CW QSK Delay allows the operator to slow the QSK action of the transceiver in CW

transmit. A higher value represents more transmit/receive delay between individual transmitted CW characters. This delay control also controls the delay of the QSK amplifier keying loops and the delay set for the outputs at AMP KEY 1 and AMP KEY 2. The default value is 20%.

Internal Keyer can be turned on and off via the menu system if desired. Please note that when the radio is in a CW mode that the keyer can also be turned on and off from the front panel by pressing **SP**. See the description of **(19) SP** in Chapter 2.

CW Weighting refers to the 3:1 dit:dah ratio employed by the CW keyer for transmitting Morse code. The length of each dah sent is three times that of a dit, relative to the spacing between the elements. The default value is 100%, with an adjustable range of 50% to 150%. As weighting increases in percentage, dits and dahs become longer in length, maintaining the 3:1 ratio. As weighting percentage decreases, dits and dahs become shorter, maintaining the 3:1 ratio.

Sidetone Pitch is the CW offset from carrier that is used for listening to CW on the ORION II. Turn the MULTI knob to adjust. This value is also adjustable from the front panel while pressing and holding the SPOT button and turning the MULTI knob simultaneously. Also see the description of **(30) SPOT** in Chapter 2.

CW Rise/Fall allows the operator to adjust the rise and fall time of the transmitting CW envelope for more or less rise time. The adjustable values are 3 ms to 10 ms, depending on whether the internal keyer or external keying is used, and the speed at which the internal keyer is set. The default value is 5 ms. Lower values like 3 ms will result in a "harder" keying sound with a quicker slope from keying initiation to full envelope and back. Higher values result in more gentler slopes for the CW transmit envelope on the "make" and "break" and result in a softer transmitted CW note.

For the internal keyer, 3 to 10 ms is available at speeds up to 30 WPM. Past 30 WPM, the available values are 3 to 5 ms. Keying at "softer" rise and fall times above 30 WPM can result in "mushy", non-definitive sounding CW transmit.

For external keying, the rise and fall times available are 3 ms to 5 ms regardless of the keyer speed.

Key PTT in SSB determines whether or not the ORION can be put into SSB transmit mode by a closure to the front or rear panel key jacks. If set to “on”, pressing a CW key (or some other closure to ground connected either of the key jacks) will put the radio into transmit in SSB modes. If set to “off”, the radio will not be put into SSB transmit in SSB modes when a closure to ground is present at one of the two key jacks.

PTT in CW as determines the action of the transmitter in relation to a PTT signal appearing either at the front panel microphone jack or pin 3 on the AUX I/O jack on the rear of the transceiver. Please note this menu item does NOT affect anything plugged into either the front panel or rear panel key jacks.

All of the below only applies when the transceiver is being used in LCW or UCW modes.

When set to “key”, a PTT closure at the mic jack or on pin 3 of the AUX I/O jack will result in a transmitted CW signal. A closure to ground will key the radio keydown in CW mode. An external keyer connected to either the mic jack or AUX I/O pin 3 can be used for transmitting CW.

When set to “mox”, a PTT closure at the mic jack or on pin 3 of the AUX I/O jack will result in the radio being put into potential transmit. PTT will close, but no signal will be transmitted. A CW signal (from an external source) can then be injected via one of the two key jacks and the ORION will transmit CW. When finished, open the closure and the radio returns to receive. This function can be used to override QSK operation from an external source and/or provide exact PTT switching from an external source.

When set to “none”, ORION will not respond to a PTT closure to ground or a closure at AUX I/O pin 3 when in CW modes.

Recommended reading: See **EXTERNAL CW OUTPUT PLUS CW KEYS OPERATION FROM PADDLES** in Chapter 4 for practical application.

Keyer Mode allows the user to toggle between Curtis A and Curtis B modes when using the ORION II internal keyer for CW operation.

(VOX) VOX MENU

Figure 3-3 VOX Menu

VOX Trip Level	29 %	
Anti-Vox Level	22 %	
Vox Hang	1.00 sec	<input type="button" value="TX"/>
		<input type="button" value="CW"/>
		<input checked="" type="button" value="VOX"/>
		<input type="button" value="RX"/>
		<input type="button" value="Other"/>
		<input type="button" value="SSB"/>
		<input type="button" value="Filter"/>

The VOX menu is accessible by pressing the button on the front panel immediately to the right of the screen next to the “VOX” annunciator.

VOX Trip Level is the gain level required to put the radio into transmit. This control determines how sensitive the VOX circuitry is to input from the microphone.

Anti-Vox Level is set to prevent tripping of the VOX circuitry. Set as needed to prevent receiver audio through the speaker from putting the radio into transmit.

Vox Hang is used to define how long the VOX remains engaged after the end of a transmission. This is set to prevent the radio from cycling back and forth between transmit and receive during the course of a normal conversation.

(RX) RX MENU

Figure 3-4 RX Menu

Sweep Range	72 kHz	
Main AGC: Hang	00.00 S	<input type="checkbox"/> TX
[slow] Decay	10 dB/S	
Threshold	03.03 uV	<input type="checkbox"/> CW
Sub AGC: Hang	00.00 S	
[med] Decay	40 dB/S	<input type="checkbox"/> VOX
Threshold	03.03 uV	
PBT Track	off	<input checked="" type="checkbox"/> RX
BW Track	off	
Hardware NB	off	
Main RX Sql	-127 dBm	<input type="checkbox"/> Other
Sub RX Sql	-127 dBm	
PBT/BW Step	10 Hz	<input type="checkbox"/> SSB
		<input type="checkbox"/> Filter

The RX menu is accessible by pressing the button on the front panel immediately to the right of the screen next to the “RX” annunciator.

Sweep Range is used for setting the range of the real-time spectrum scope that is available on the main receiver. There are 5 selectable widths of: 4.5, 9, 18, 36, and 72 kHz.

AGC is Automatic Gain Control and is used to provide a reasonably uniform output at audio from incoming signal strengths of varying intensity.

One of the most useful, revolutionary new features of ORION II is fully programmable AGC. AGC action can be programmed to taste on each receiver for **FAST**, **MED** and **SLOW** settings, and a fourth setting, **PROG**, allows the user to adjust any and all of the AGC characteristics.

Refer to Figure 3-4 above. To adjust a given parameter for each receiver, first select the desired AGC on the receivers before entering the menu system by using the AGC button (see **(33) AGC** in Chapter 2).

For **FAST**, **MED**, and **SLOW**: The hang and threshold parameters are fully adjustable. AGC hang is the amount of time that the AGC remains actuated before decay begins. Threshold is the point at which a signal of a given strength (expressed in microvolts) will actuate the AGC system. The threshold value in the AGC system acts like an IF gain control for the DSP part of the receiver chain

– turn the value low and the receiver gain comes up, as may signal levels and extraneous noise. Decay is used to determine how fast the IF gain increases in the absence of a signal above the threshold value.

The hang value for **FAST**, **MED**, and **SLOW** is adjustable from 0 to 10.92 seconds. The threshold value for **FAST**, **MED**, and **SLOW** is adjustable from 0.37 uV to 191.48 uV. The decay values available are **FAST**, 80-200 dB/second, **MED**, 20-80 dB/second, **SLOW** 5-20 dB/second.

The factory default values for **FAST**, **MED**, and **SLOW** are **FAST**: hang 0.00, decay 80 dB/s, threshold 3.03 uV, **MED**: hang 0.00, decay 40 dB/s, threshold 3.03 uV, **SLOW**: hang 0.00, decay 10 dB/s, threshold 3.03 uV. These default settings apply to both the main and sub receivers. Any default value for a given AGC setting (**FAST**, **MED**, and **SLOW**) can be instantly restored to factory default value merely by pressing the MULTI knob encoder toward the front panel while the parameter is highlighted in the menu.

The **PROG** (programmable AGC) setting provides full adjustment of all parameters in the AGC system. In addition to the hang and threshold values being fully adjustable as they are with **FAST**, **MED**, and **SLOW**, the programmable AGC setting allows the decay rate to be adjusted over its full range from 5 to 2000 dB/second.

AGC is an important characteristic of overall receiver performance for contesting and weak signal DXing. Please also read the section in Chapter 4 of this manual titled “**Optimal Uses of ORION II Receiver for Weak-Signal DXing and Contesting**”.

PBT Track and **BW Track** are used to simultaneously set the PBT and BW values for each receiver with one turn of the MULTI knob. The default value is “off”, allowing the PBT and BW values to be adjusted separately by receiver. If it is desirable to adjust both PBT and BW on both receivers at the same time, this control can be set to “on”. Additionally, BW setting can be copied between VFO A and VFO B when using the A>B, B>A, or A/B buttons on the front panel if this value is set to “on” (default is that BW information is not copied between

VFOs when frequency information is exchanged).

Hardware NB allows the hardware noise blanker available for the main receiver to be turned on and off. This additional noise blanking system for the main receiver only can either be used together with or independently of the software noise blanker. When activated, the area just above the NB button on the bottom of the radio screen will show the annunciator **:H** next to any value set for the software noise blanker. The hardware noise blanker can also be activated without going into the menu system by pressing and holding the NB button for two seconds. Also see the description of the software noise blanker in Chapter 2 under **(23) NB**.

Main RX Sqi is the squelch threshold for the main receiver. It represents a signal threshold measured in -dBm. The higher the value, the more receive signal will be needed to break the squelch. Adjust by turning the MULTI knob.

Sub RX Sqi is the squelch threshold for the sub receiver. It represents a signal threshold measured in -dBm. The higher the value, the more receive signal will be needed to break the squelch. Adjust by turning the MULTI knob.

PBT/BW Step allows the operator to choose in what step size the PBT/BW encoder selects filter bandwidths and PBT values. The available choices are 10, 50 and 100 Hz.

(OTHER) OTHER MENU

Remote Pod F1	VFO A/B	
Remote Pod F2	Step	<input type="text" value="TX"/>
Remote Pod F3	Mode	
Rem Pod Enter	VFO B Ent	<input type="text" value="CW"/>
Menu Delay	off	
Backlight	High	
VFO-A Enc Rate	Slow	<input type="text" value="VOX"/>
VFO-B Enc Rate	Slow	
CW RIT Rate	Slow	<input type="text" value="RX"/>
SSB RIT Rate	Slow	
POD Enc Rate	Slow	<input type="text" value="Other"/>
LCD Display	Black/White	
FSK Tx Data	Mark Low	
Remote Pod Enc	VFO-A	<input type="text" value="SSB"/>
Line Out Src	Main	
Line Out Level	High	<input type="text" value="Filter"/>

Figure 3-6 Other Menu

The Other menu is used for ORION II functions that do not fit into one of the other menu categories.

Remote Pod F1, Remote Pod F2, and Remote Pod F3 refer to the control of radio functions available via the F1, F2, and F3 buttons on the accessory model 302R remote encoder/keypad available for ORION II. If you do not have the 302R connected, they will have no function.

To scroll through the available choices for each of **Remote Pod F1, Remote Pod F2, and Remote Pod F3**, turn the MULTI knob.

VFO A/B duplicates the function of the A/B button on the front panel (see **(60) A>B, B>A, A/B** in Chapter 2). This flips the two frequencies shown, copying A to B and B to A.

Step duplicates the function of the STEP button on the front panel (see **(31) STEP** in Chapter 2). Unlike the front panel STEP button, the step sizes available are selected via repeat pushing of the F1, F2, or F3 button depending on which is being used. The radio will cycle through the seven available step sizes.

Mode duplicates the function of the MODE button on the front panel (see **(27) MODE** in chapter 2). Unlike the front panel MODE button, the step sizes available are selected via repeat pushing of the F1, F2, or F3 button depending on which is being used. The radio will cycle through the seven available modes.

Sweep on/off duplicates the function of the SWEEP button on the front panel (see **(32) SWEEP** in Chapter 2). The real-time spectrum sweep on the main receiver can be turned on and off.

USER 1 and **USER 2** are duplicates of the front panel USER 1 and USER 2 buttons (see **(21) USER 1** and **USER 2** in Chapter 2). These allow retrieval of the profile memories that are stored in USER 1 and USER 2.

Send 1, Send 2, and Send 3 are duplicates of the SEND 1, SEND 2 and SEND 3 buttons found on the front of the ORION (see **(20) SEND 1, SEND 2, SEND 3** in chapter 2). They are used for sending memory information stored in either the CW keyer or voice memories.

VFO A Ent and **VFO B Ent** allow direct frequency entry off the keypad for either VFO A or VFO B.

The **Rem Pod Enter** setting determines where a band change from the keypad is sent (VFO A or VFO B). The ten button keypad on the 302R accessory duplicates the band change keypad on the ORION II unless a function button has first been pushed for direct frequency entry. Push “9” to change to 40m, “7” to change to 160m, etc. Note that the 302R buttons are not arranged in the same numerical order as the keypad on the ORION II; it is the location of the button in the matrix rather than the number on the button on the 302R that determines to what band the radio is changed.

Menu Delay is used to set the encoder tuning rates and button responses while using the menus.

Backlight is used to determine the brightness of screen characters. High, Med, Low are available choices.

VFO-A Enc Rate and **VFO-B Enc Rate** have settings of “fast” and “slow”. Unlike tuning STEP as set via the STEP button, the **Rate** controls are used to determine how many steps per revolution of the two main tuning knobs are made. The “fast” rate is 4x the “slow” tuning rate

Like the main tuning knob rates, **CW RIT Rate** and **SSB RIT Rate** are used to vary the rate, but not the step size, of the RIT encoder. The “fast” rate is 4x the “slow” tuning rate.

If the optional model 302R encoder/keypad is in use, **POD Enc Rate** can be used to control the tuning knob rate. The “fast” rate is 4x the “slow” tuning rate.

LCD Display selects color schemes for the screen. Turn the MULTI knob to select different pre-set color setups.

FSK Tx Data is used to determine whether the MARK tone in FSK operation is on the high tone (2295 Hz) or low tone (2125 Hz). The standard is for FSK to use the low tone for MARK. FSK direct to the radio from a computer sound card (no TNC) should have this set to ‘high’ so tones will not be inverted. See the description for **FSK OPERATION** in Chapter 4.

Remote Pod Enc is used for the accessory 302R remote encoder/keypad. The 302R’s main tuning knob can be used as a duplicate of VFO A or VFO B by selecting either VFO-A or VFO-B on this menu line item. The 302R main tuning knob can also be used for RIT/XIT or PBT/BW operation by selecting RIT/XIT or PBT/BW on this menu line item.

Line Out Src determines which receiver audio output is sent as line level to the line level audio output at pin 4 on the rear panel AUX I/O jack. Choices are Ma in, Sub, Both.

Line Out Level determines the level of output at the pin 4 AUX I/O jack. Settings are High, Med, Low – for most applications (like digital modes) the High setting will be used.

(SSB) SSB MENU

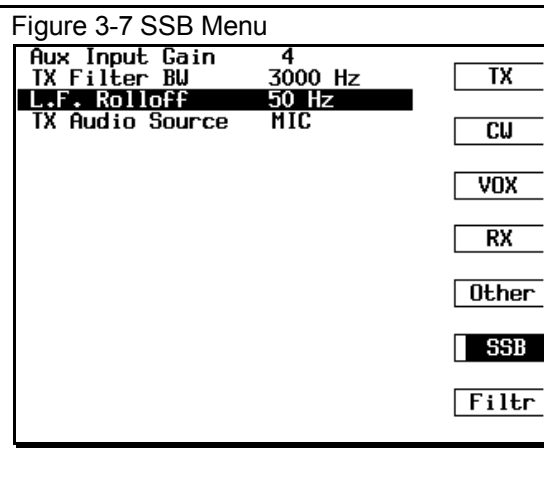

The SSB menu is used for adjustment of SSB transmit options.

Aux Input Gain is used for adjusting audio gain from an accessory device using the line level aux input available on pin 1 of the rear panel AUX I/O connector.

TX Filter BW controls the SSB transmit filter bandwidth. The maximum bandwidth usable by ORION II is 3.9 kHz. Wider bandwidths (above 3 kHz) have a more full-range sound to transmitted SSB audio; narrower bandwidths are “communications grade” SSB audio. Typical communications audio for TX Filter BW would be 2.7 kHz.

L.F. Rolloff refers to the point where low end audio response starts for transmitted

SSB audio. For example, if **TX Filter BW** is set to 3000 Hz and **L.F. Rolloff** is set to 200 Hz, the frequency response of the transmitted signal is 200 Hz on the low end to 3200 Hz at the high end. Moving **L.F. Rolloff** to 100 Hz would move the transmit passband to 100 Hz to 3100 Hz for a 3000 Hz bandwidth. The available values are a minimum of 50 Hz to a maximum of 300 Hz.

TX Audio Source allows the radio to have audio input through either the front panel mic jack or via the AUX input on pin 1 of the rear panel AUX I/O connector. The available choices are MIC, AUX or BOTH.

Please also see the description for setting up SSB transmit audio in Chapter 4.

(FILTR) FILTER MENU

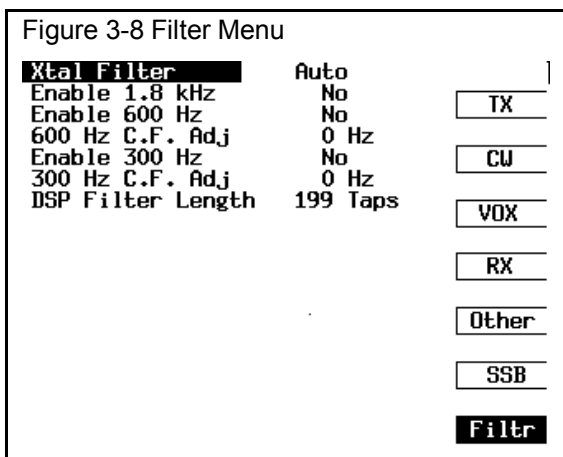

Please refer to the discussion of filtering in Chapter 1. ORION II provides for up to seven available mode-appropriate **I-F roofing filters**, not to be confused with traditional bandwidth filtering as provided for in DSP. Optional roofing filters of 1.8 kHz, 600 Hz, and 300 Hz in the ORION II need to be activated to be used by the operator. Please note: If you activate an optional filter position and no filter is installed, the radio will mute on receive!

Activating the optional filters is simple. For each of the 1.8 kHz, 600 Hz, and/or 300 Hz optional filters that you have installed, use the MULTI knob to change the setting from “no” to “yes”.

Roofing filters can automatically be selected by the radio or the operator has the option of

override to select one specific filter to be used at all times. The available choices are 20 kHz, 6 kHz, 2.4 kHz, 1.8 kHz (if installed), 1 kHz, 600 Hz (if installed), 300 Hz (if installed).

For automatic selection of appropriate roofing filters, put the **Xtal Filter** setting on AUTO. When using the DSP BW filtering in the ORION II (see description of **(41) PBT B/W ENCODER** in Chapter 2), as a threshold for each filter is crossed, the roofing filters will automatically be selected. Example: After selecting AUTO, press MENUS to exit out of the menu system and return to normal radio operation. As the DSP bandwidth is narrowed, the filters will be selected or de-selected at a value somewhat below that of the roofing filter. For example: the threshold where the 6 kHz filter switches out to the 2.4 kHz filter in AUTO mode is 2390 Hz. On the screen, the roofing filter is represented by a horizontal line on top of the DSP BW filter shape. The line will widen or narrow as the roofing filters switch in and out.

It is possible to override the AUTO setting and use one specific filter at all times. To do so, turn the MULTI knob while **Xtal Filter** is highlighted in the menu and pick a roofing filter. Regardless of DSP BW setting, this selected filter will be in use as the roofing filter. Remember: optional roofing filters, must be installed and enabled. Selecting a non-installed filter will mute the receiver. If selecting an installed optional filter that is not enabled, the next highest value will be the actual filter in use.

Each of the 600 Hz and 300 Hz optional roofing filters used in ORION must be centered. While DSP very accurately repeats from unit to unit, crystal filters do not because of individual unit manufacturing tolerances. Set your CW offset to desired value via the **CW MENU**. Tune in a carrier of reasonable strength (S7 is good), at your CW offset. Use the **Xtal Filter** control in the menu to select the filter you want to center. Then move down to either **600 Hz C.F. Adj** or **300 Hz C.F. Adj** depending on your filter selection. Adjust the MULTI knob for a received signal peak. You will not have to re-adjust these unless you do a subsequent master reset of the radio.

DSP Filter Length - The DSP filter length is essentially how sharp (or not) the DSP bandwidth filters are. The higher the value indicated, the better the shape factor of the DSP BW filtering. The default value is 199, which is the highest setting. Lower values decrease the shape factor of the filters, which can improve well-rounded audio sound of received SSB and AM signals, at the expense of receiver selectivity. Higher values = sharper, more selectivity on receive. Lower values = less sharp, worse selectivity on receive, but for casual SSB and AM operation with no interfering signals present in the receiver passband may be desirable.

Chapter 4 – OPERATION AND ACCESSORY CONNECTION EXAMPLES

BASIC TRANSCEIVE OPERATION

Refer back to the operating instructions in Chapter 2 for **(8 – 13) VFO ASSIGNMENTS**. The most important point to consider is that VFO's are not receivers. Both receivers can be assigned to one VFO if desired.

Typical transceive operation would be to have the main receiver and the transmitter on VFO A, and the subreceiver on VFO B.

To do so, press buttons as shown below in Figure 4-1. Under VFO A, the buttons next to TX and RX are lit, under VFO B the SUB RX button is lit.

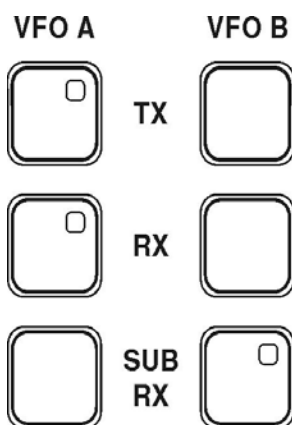

Figure 4-1. VFO selection for transceive with main RX/TX on VFO A, subreceiver VFO B.

VFO A is always the main tuning knob closest to the screen – VFO B is always the main tuning knob at the far right of the ORION II.

Turn the MAIN AF knob to increase main receiver volume. Turn the SUB AF knob to increase sub receiver volume. Either of these can be muted by pressing the encoder towards the radio face. To unmute, press or turn the knob.

The AUDIO menu determines the mix of main receiver and sub receiver audio heard through the speaker or the headphones. See the Chapter 2 description for **(36) AUDIO**.

Antenna selection is determined by the matrix of six buttons at the far left of the

radio. A complete description is provided in Chapter 2 under **(2 –7) ANTENNA ASSIGNMENTS**.

OPERATING SPLIT FREQUENCY

Often DX stations will be listening on one frequency while transmitting on another. The two receivers and two VFO's in the ORION II permit the operator to listen to both the DX stations frequency and the frequency where the DX station is listening for calls simultaneously. There is no SPLIT button, but setting up split frequency operation only requires pressing the A>B button as shown below.

An example using the typical transceive setup of main RX/TX on VFO A and subreceiver on VFO B: A DX station is transmitting on 14.195 MHz and listening for calls on 14.210 MHz. Tune in the DX station on 14.195 on VFO A. Press A>B to equalize the frequencies on the two VFO's. Tune VFO A to 14.210. You are now listening to the DX station on the subreceiver on VFO B on 14.195 and are ready to transmit (and listen) on 14.210 using the main receiver.

For weak DX stations operating split frequency, it is probably advantageous to use the main receiver for listening to the DX station and using the subreceiver frequency for monitoring the pileup and your transmit frequency. Starting from the same example of main RX/TX on VFO A and subreceiver on VFO B, DX station on 14.195 listening on 14.210: Tune in the DX station on 14.195 on VFO A. Press A>B to equalize the frequencies on the two VFO's. Tune VFO B to 14.210. Press the button next to TX, under VFO B. You are now listening to the DX station on the main receiver on 14.195 on VFO A, and are listening and ready to transmit on 14.210 with the subreceiver and transmitter on VFO B. See Figure 4-2 for assignment of VFO buttons.

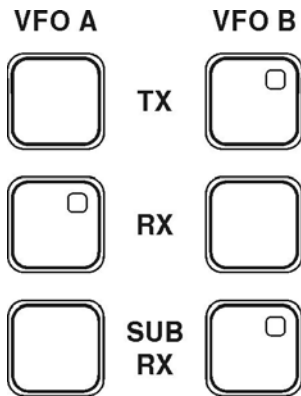

Figure 4-2. Split frequency operation with DX station being received on main receiver via VFO A, subreceiver monitoring of pileup and transmit frequency on VFO B.

OPERATING THE INTERNAL ANTENNA TUNER (if installed)

Your ORION II may be equipped with an internal automatic antenna tuner. If installed, the tuner is active on the ANT 1 jack only, and has a load impedance range of 6 to 800 ohms (up to 10:1 SWR).

The tuner can be enabled or disabled from the menu system. The default condition is to have the tuner enabled. To enable or disable, press MENUS then select the TX menu. The first line item in the TX menu is **Internal Tuner**. Use the MULTI knob to turn the tuner on or off.

The tuner is activated by pressing the **TUNE** button on the front panel. The rig will transmit a keydown CW carrier at approximately 20 watts output. The tuner will activate and tune. When finished, the CW carrier will stop and **tuned** will appear on the screen just above the sub receiver s-meter (where SWR is normally shown).

The tuner will usually stop at a value of 1.5:1 SWR or lower. Occasionally it may present a slightly higher SWR after tuning. This is normal, and the transceiver will still transmit at full output power with no foldback.

The tuner does not automatically reactivate when presented with a higher SWR after changing frequency. If the tuner was tuned on 14.025 MHz and you later moved to 14.200 MHz, the tuner may require re-tuning and can be activated again with the TUNE feature. However, as the internal tuner in ORION II is an L-network (assuring broadband matching) you may find the

range of the tuner when tuned to be larger than that found on HF transceivers from other manufacturers that use a Pi- or T-network tuning arrangement.

There is no memory feature; the tuner will not retain the last setting for a particular band or frequency.

CONNECTING AN EXTERNAL LINEAR AMPLIFIER

Whether you have an amplifier that is full break-in, and how the full break-in is accomplished, will determine the method for connecting the linear to ORION II.

Two sets of keying outputs are provided for the two available antenna jacks on the radio. AMP KEY 1 and TX OUT / TX EN 1 are used for a linear connected via the ANT 1 jack. AMP KEY 2 and TX OUT / TX EN 2 are used for a linear amplifier connected via the ANT 2 jack. RF appears approximately 15 mS after closure of either AMP KEY 1 or AMP KEY 2.

Non-QSK linear amplifiers or QSK linears that do not employ the use of a keying loop are keyed from the AMP KEY 1 and AMP KEY 2 jacks (see **(66) AMP KEY 1** and **(68) AMP KEY 2** in chapter 2). Connect the PTT keying line of your linear amplifier to the AMP KEY 1 or AMP KEY 2 jack as desired using a shielded cable with RCA-style male phono connectors at each end.

ORION II is equipped with a QSK delay feature accessible via the **CW MENU** that operates on both the AMP KEY 1 and AMP KEY 2 connections and the TX OUT / TX EN 1 and TX OUT / TX EN 2 keying loops. This will allow you to set the amount of delay between CW characters desired. Also see the description in chapter 3 under **(CW) CW MENU**.

NOTE: The external amplifier key line should not apply more than +100V (output inactive) nor should it draw more than 250 mA (output active). Many older linear amplifiers like those manufactured by Collins, Drake, and Heathkit have a higher voltage on the keyline. Such amplifiers **require** a relay or transistor switch between either ORION II AMP KEY jack and the amplifier PTT keyline. If you are unsure if your amplifier is suitable, please consult the

operator's manual for your amplifier or contact the Ten-Tec service department.

An adjustable delay is available for each of the AMP KEY jacks. These are titled **EXT T/R Delay 1** and **EXT T/R Delay 2**. These give the operator the ability to have the amplifier keyed longer by the radio, preventing drop outs between words of SSB or CW operation. **EXT T/R Delay 1** and **EXT T/R Delay 2** are found in the TX submenu under MENU.

Some QSK linear amplifiers incorporate the use of a full break-in keying loop. Ten-Tec linear amplifiers use a full break-in keying loop to assure proper sequencing of the keying between the radio and the amplifier.

To use the ORION II with a full break-in linear amplifier incorporating a keying loop, use the TX OUT 1 / TX EN 1 or TX OUT 2 / TX EN 2 jacks as appropriate for an amp connected to the ANT 1 or ANT 2 jacks.

Connect TX OUT 1 to the keying loop input on your amp. On Ten-Tec amplifiers, the corresponding jack is marked KEY IN. Connect TX EN 1 to the keying loop output on your amp. On Ten-Tec amplifiers, the corresponding jack is marked KEY OUT. Place the amp in QSK mode. The amplifier will be used in all modes in the QSK position.

Please note: To use a full break-in keying loop, it must be enabled from the MENU. The keying loops are turned on and off via the TX submenu in the MENU (see the **TX MENU** description in Chapter 3). If the loop is turned on, and no connections are made it will prevent the ORION II from transmitting.

TUNING UP AN EXTERNAL LINEAR AMPLIFIER

The TUNE button on the front panel can be used for initial linear amplifier tune-up. If an automatic antenna tuner is installed in your ORION II, go into the **TX MENU** and disable it. Pressing the TUNE button will provide approximately 20 watts of keydown CW carrier output to be used for an initial tune-up of your linear.

It may be desirable to increase the keydown power output when tuning your amplifier. To do so, press the PWR button after pushing the TUNE button. Power output will move from the low power setting to whatever level

the PWR control has been set at with the MULTI knob. Repeat operation will require pushing TUNE then PWR again for the higher output value.

FACTORS THAT AFFECT THE SOUND OF SSB TRANSMIT AUDIO AND THEIR ADJUSTMENT

One of the features of ORION II is a lot of flexibility afforded the operator for the desired sound of SSB transmit audio. Many possible settings are available so that operators with different styles (or philosophies) can adjust the radio the way they want it to sound. Obviously, the operator who favors rich, full-sounding transmit audio is not going to have the same needs as the DXer who wants maximum "oomph" to try and break an SSB pileup.

There are several controls that interact on ORION II for SSB transmit audio. Every operator is different; we use different microphones, the timbre of voices are different, distance from the microphone will vary. What we intend below is to describe what is used to tailor transmit SSB audio, and then encourage the operator to experiment with the settings to find the sound they want.

A monitor function (button marked **MON**) on the front panel has been provided for the operator to listen to the sound of actual transmitted SSB audio. We recommend using headphones while using the **MON** circuit to prevent microphone/speaker feedback. See the description of **(18) MON** in Chapter 2.

There are five radio controls used for SSB transmit audio. 1) Transmit bandwidth, which is adjusted using the **TX Filter BW** control in the SSB menu. 2) Low frequency rolloff, adjusted with the **L.F. Rolloff** control in the SSB menu. 3) Transmit equalization, labeled **TX EQ**, which is adjusted in the AUDIO submenu found by pushing the AUDIO button on the front panel. 4) **Mic** gain, adjusted via the front panel **MIC** button. 5) Speech processing, adjusted via the front panel **SP** button.

Transmit bandwidth is both the frequency response of the transmitted signal and the amount of spectrum occupied by that signal. Typical communications-grade audio for SSB is in the 2.4 to 2.7 kHz range. Some

“hi-fi” SSB enthusiasts have been experimenting with larger transmit bandwidths in an effort to improve the quality of audio transmitted, and ORION II has been provided with the ability to transmit on SSB with a maximum bandwidth of 3.9 kHz. Please see the note toward the end of this section about wide SSB transmit bandwidths and their potential ramifications.

Set the **TX Filter BW** in the SSB menu to an appropriate value based on your operating preferences. For communications-grade audio, we recommend starting the ORION II transmit bandwidth at 2.55 kHz (2550 Hz). For more well-rounded transmit audio, start the transmit bandwidth at 3.0 kHz (3000 Hz). The ORION II default value for this setting is 3000 Hz.

The next control to adjust is **L.F. Rolloff**, also found in the SSB menu. **L.F. Rolloff** refers to “low frequency rolloff”. This control interacts with the **TX Filter BW** to determine your frequency response.

For example, if the **TX Filter BW** is set to 3000 Hz, and **L.F. Rolloff** is set to 150 Hz, the response envelope for your transmitted SSB signal is a low of 150 Hz and a high of 3150 Hz for a total bandwidth of 3000 Hz. Using the same 3000 Hz **TX Filter BW** setting, if the **L.F. Rolloff** is changed to 50 Hz, the response envelope is now a low of 50 Hz to a high of 3050 Hz, for a total bandwidth of 3000 Hz. You can think of the **L.F. Rolloff** control as where the “bass response” from your voice and the transmit bandwidth is attenuated.

The next control to adjust is transmitter equalization. TX EQ can be used to give your audio more bass or treble response at a given transmit bandwidth and low frequency rolloff setting. It can also be used to compensate for a microphone with more bass or treble response. ORION II is provided with audio equalization for the transmitter. It enables tailoring audio frequency response for greater effectiveness and to accommodate your preferences. The TX EQ establishes a specific audio profile for your transmitted audio from either the MIC or AUX audio input sources. The TX EQ effects from high pitched at -20 dB to essentially flat response at 0 dB to very bassy at +20 dB. It is adjustable in 1-dB steps.

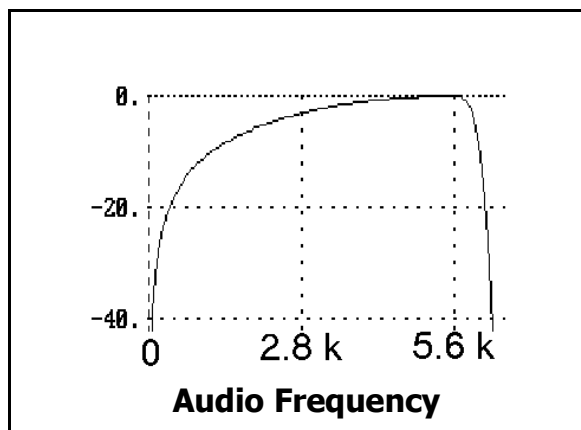

Figure 4-3 High RX EQ Response (-20 dB)

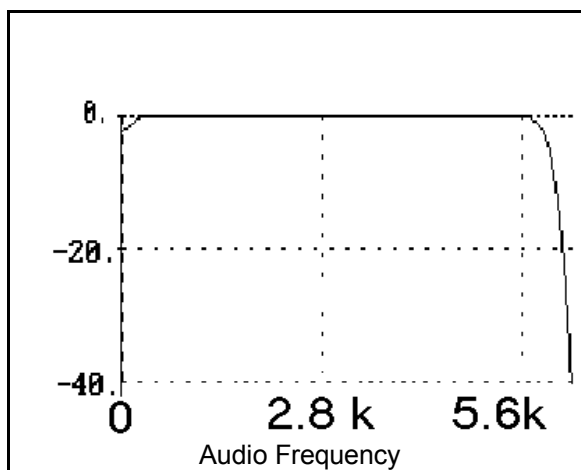

Figure 4-4 Flat RX EQ response (0 dB)

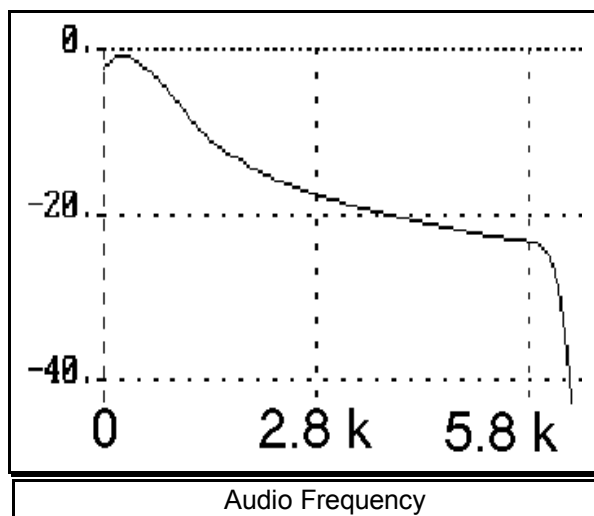

Figure 4-5 Low RX EQ Response (+20 dB)

Refer to Figures 4-3, Figure 4-4, and 4-5. They illustrate responses in the center and at the extremes of the equalization controls.

The displayed setting of the equalizers refers to the amplitude in dB (at about 100 Hz) relative to the highest frequency in the passband. For example, the -20 dB setting produces -20 dB at 100 Hz relative to 0 dB.

Generally, the **TX Filter BW**, **L.F. Rolloff**, and **TX EQ** controls are set once and not adjusted again unless you change microphones or want to experiment with different SSB sound.

The two most-used SSB transmit controls will be mic gain (accessible from the **MIC** button on the front panel) and the speech processor (accessible from the **SP** button on the front panel).

Mic gain is set by pressing the **MIC** button and talking into the microphone. When you have reached proper ALC, the red ALC LED located next to the S-meter on the front of the radio will flash on voice peaks. Adjust the mic gain upward until the ALC light is flashing on and off while you are transmitting. Different microphones will require more or less gain. The Ten-Tec model 706 communications desk microphone will require a small amount of gain. Microphones like those manufactured by Heil Sound may require more gain. This is normal.

Speech processing (**SP**) is provided to give the operator more “punch” to the transmitted signal. Speech processing increases the average amplitude relative to the peaks for an increase in average power transmitted. Press the **SP** button (if desired) and use the **MULTI** knob to adjust the speech processing level. Speech processing is generally not used for higher-fidelity SSB audio; its use is primarily for added intelligibility for communications-grade SSB audio. It is also possible with high levels of speech processing and combinations of microphone and other settings available to send the transmitter into distorted SSB output. Use the **MON** function to listen to what you are transmitting and avoid this.

The speech processor used in the ORION II is a true RF compressor, DSP generated. Human voices have peak-to-average ratios

as high as 15 dB. At 100 watts PEP output, the average output power might be as little as 3 watts! RF compression raises the average output power and tends to improve intelligibility by bringing out subtle parts of speech. With a digitally generated RF speech processor, we have the advantage of calculating the RF envelope before the modulation is performed. Microphone audio is sampled and converted to an analytic signal, and an equation is used to compute the envelope.

Note on wide SSB transmit bandwidths: Audio fidelity generally improves with the use of wider SSB transmit filtering. Using a 3.0 kHz or higher bandwidth will have a more “well-rounded” audio response than a narrower bandwidth. As transmit bandwidth widens, so does the potential for interference with stations using adjacent frequencies.

Part 97 of the FCC regulations governing amateur radio operation does not specify a maximum transmit bandwidth usable by amateurs for SSB communication. However, FCC regulation 97.307(a) requires amateur stations not to occupy more bandwidth than is necessary for the emission type being transmitted in accordance with good amateur practice. Regulation 97.307(b) requires that emissions outside the necessary bandwidth must not cause splatter interference to operations on adjacent frequencies.

While these are broad regulations subject to interpretation, the responsibility for complying with the regulations rests with the operator. Using an SSB transmit bandwidth wider than necessary for communications and causing interference to adjacent stations while doing so is specifically what these regulations are addressing. In summary, what may be an acceptable bandwidth on a given band at a given time may not be on another band at another time.

See Figure 4-6 for some initial settings for various microphones. Remember your results will vary, and these are just suggested starting points.

Input Source	Input Device	MODE	MIC Gain	AUX Gain	TX EQ
Heil Goldline	MIC	SSB	65	zero	-6 dB
Ten-Tec Desk Mic	MIC	SSB	40	zero	0 dB
Sound Card Interface	AUX	PSK31	zero	75	-14 dB
Sound Card Interface	AUX	MFSK	zero	55	0 dB

Figure 4-6 Initial Suggested Microphone Settings

SETTING UP ORION II FOR AM TRANSMIT

The same factors that affect SSB transmit also come into play for AM transmit operation as well. Speech processor, low end rolloff, TX bandwidth, mic gain, and TX EQ are all used for AM operation as well.

Transmit bandwidth in AM operation is doubled from that shown in the SSB menu. AM transmit bandwidth is still set from the SSB menu, but the value selected is doubled for AM operation. To select a 6 kHz AM transmit bandwidth, select 3000 Hz in the SSB menu as the transmit bandwidth.

Carrier amplitude for AM operation is set automatically by ORION II. The PWR control on the front is used for PEP output power setting in AM operation. A value of 100 would correspond to 100 watts PEP AM output, or 25 watts carrier power maximum.

FSK OPERATION

Selection of the FSK mode will allow the ORION II to operate true FSK RTTY. The FSK circuitry is controlled through the rear AUX I/O jack on the rear panel of the transceiver.

Pin 7 on the I/O jack is the MARK/SPACE input. This input is typically connected to the FSK output on a modem or terminal unit. The ORION II receives FSK using lower sideband. The center of the filter passband is preset so any bandwidth filter used will be centered on the standard FSK MARK/SPACE 2125/2295 Hz tones.

The ORION II display indicates the transmit MARK frequency. There is also a user-control called **FSK Tx Data** in the Other menu for selecting whether the MARK is the low tone or high tone (the standard is low tone). This allows the transceiver to be used with either TTL or open-collector keying schemes.

The monitor function is available in FSK mode and may be used to monitor the transmitted tones. (See **(18) MON** in Chapter 2).

TRANSVERTER HOOKUPS

ORION II provides the ability for a VHF transverter to be connected to the rear panel via the XVRT KEY, XVRT RF, and AUX RX jacks on the transceiver rear panel.

Both the XVRT KEY and XVRT RF transverter support connections are activated via the TX menu. Enter the TX MENU (see description under **TX MENU** in Chapter 3), and use the MULTI knob to turn the transverter output on. This will activate both the XVRT KEY jack and send RF output through the XVRT RF jack.

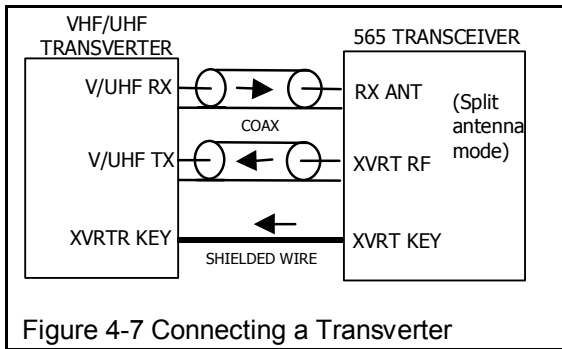

Figure 4-7 Connecting a Transverter

Basic connection for a transverter is shown in Figure 4-7. The receive side of the transverter is connected to the AUX RX jack. On ORION II, select VFO A for transceive operation by pressing the TX and RX buttons on the front panel in the VFO A column under the S-meter. Select RX ANT for MAIN RX/TX on the front panel.

The transmit side of the transverter is connected to the XVRT RF jack. XVRT RF provides a low level output RF output of approximately +15 dBm - this output is ALC controlled and is adjustable from +5 to +15 dBm by using the PWR and MULTI control when the transverter output has been activated in the menus.

XVRT KEY is for the PTT connection of your transverter.

It may be desirable to employ the use of a sequencer for proper key sequencing of transverter, radio, linear amplifier, etc. ORION II can easily be used with a sequencer. The last relay output to close on the sequencer should be connected to the TX EN 1 jack on the rear of the ORION II. Go into the menus and turn on **Keying Loop 1**. This keying loop will prevent the radio from transmitting until a closure to ground appears at the TX EN 1 jack. By connecting the last relay to close on the sequencer to the TX EN 1 jack, the operator will have ensured that all required keying connections have been closed prior to RF appearing at the output of the XVRT RF jack.

DIVERSITY RECEPTION

Because the ORION II has the ability to have both receivers tuned by a single VFO simultaneously, and because both receivers can be split out to different antennas, a world of possibilities for diversity reception are opened.

First, a definition of “diversity reception”: Radio reception in which a signal is obtained by combining or selecting signals, from two or more independent sources, but which may vary in their fading characteristics at any given instant. Good examples would be the use of one horizontal and one vertical antenna or two horizontal antennas separated by one wavelength or more.

It has been shown from studies that weak and/or fading signals can be copied better when they are heard from two sources simultaneously rather than only one. As signals fade, if another source is available to simultaneously monitor the signal, the fading effect can be somewhat compensated for. This is useful not only for the weakest signals when chasing DX, but for normal communication where signal levels are fairly readable but still subject to some QSB.

Because ORION II allows you to tune two receivers with one VFO, diversity reception is possible using the two receivers on two separate antennas.

First, put both receivers on the desired amateur frequency on VFO A. To do this, merely press all three of the buttons in the VFO A column directly under the S-meter. Now both receivers and the transmitter are tuned by the VFO A tuning knob. Press ANT 1 for MAIN RX/TX and ANT 2 for SUB RX. See Figure 4-8.

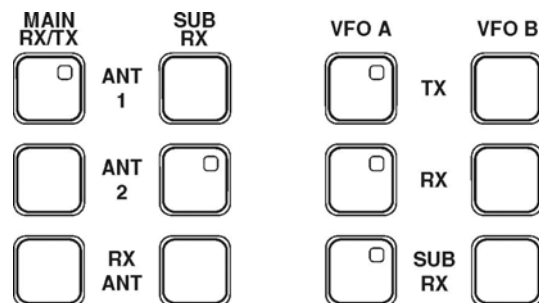

Figure 4-8. Diversity reception with both receivers on VFO A. Main receiver and transmitter are utilizing ANT 1. Subreceiver on VFO B is utilizing ANT 2.

In the AUDIO menu, either combine the audio outputs of the two receivers in both headphones by selecting “Both” for Sub and Main RX audio, or put one receiver in each ear by selecting Main: Left and Sub: Right

The ORION II is now set up for diversity reception with the main receiver and transmitter on ANT 1 and the subreceiver on ANT 2.

For low band DXing, it may be desirable to combine the outputs of the two receivers from two different receive antennas while having the transmitter use a third antenna. This is accomplished by connecting receive-only antennas to both ANT 2 and the RX ANT jacks on the rear panel, and using ANT 1 for transmitting.

Put the subreceiver on ANT 2, the main receiver on RX ANT and the transmitter on ANT 1 by pushing buttons on the front panel so they light up as shown in Figure 4-9. Again put both receivers and the transmitter on VFO A.

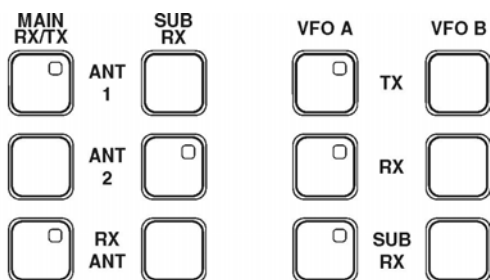

Figure 4-9. Diversity reception. Main receiver on VFO A is using RX ANT jack. Transmitter on VFO A is using ANT 1. Sub receiver on VFO B uses a second receive antenna connected to ANT 2.

Using this configuration, both receivers can use independent receive antennas while the transmitter uses a separate TX antenna, all on the same frequency. Both receivers are tuned simultaneously by turning the VFO A main tuning knob.

WEAK SIGNAL DX RECEPTION, CONTEST OPERATION AND ORION II

With most transceivers, an operator typically would set CW for a low or comfortable offset, select a narrow bandwidth filter (like 250 Hz), turn AGC to either “fast” or “off”, use some setting for DSP noise reduction and start listening for weak signals. Which is fine – **except that “typical” settings like this used for other radios simply won’t use ORION II to its maximum capabilities.**

An important point to ponder: There is **no one setting for RX combination (defined as roofing filter, DSP bandwidth filter, DSP NR, and AGC together) that is the correct one for ORION II.** There are good places to start – and by understanding how the operation of the high dynamic range receiver in ORION II is different from other transceivers will set you on the correct path toward optimum use.

Let’s think this through logically. Band conditions always vary, noise always varies, signals always vary. If you set a transceiver for one optimal setting to use it for variable conditions, would it seem logical that the operator would be using the transceiver to its optimum capability each and every time?

Refer back to the definition of the use of a crystal roofing filter. The roofing filter is used for keeping strong closeby signals from compromising receiver performance. Listening to a weak signal on a quiet band does not meet the definition of need for a tight roofing filter. On a band where few signals are present other than a desired target weak signal, only a wide roofing filter would be necessary. Using the 300 Hz roofing filter when listening to a single weak signal on the low bands gains nothing additional. In fact, it could hurt your ability to hear a noise floor level weak signal. Why? Among other reasons, all narrow bandwidth filters suffer from insertion loss – and in the Orion, like other transceivers have for many years, we use an amplifier to compensate for crystal filter loss. A 300-Hz filter is going to have slightly more loss than a 600-Hz filter. Both of these narrow filters have more loss than the 1 kHz roofing filter. The loss, after preamp compensation, is about 2 dB. **No loud signals nearby = no need for a tight roofing filter.** Regardless of **DSP bandpass filter setting**, we’d recommend

using a wider roofing filter as acceptable for weak signal DXing. The DSP bandpass filtering does not vary in gain down to the minimum setting of 100 Hz. Therefore, if there is no offending signal within 1 kHz, setting the roofing filter at 1 kHz and narrowing the DSP bandwidth to any desired value is by far the best setup for ORION II for single signal DXing.

Of course, if you have a pileup 1 kHz away, perhaps a tighter roofing filter is warranted to keep those loud callers from compromising close-in performance.

That's fine – but make sure that the **crystal roofing filters are centered.**

DSP noise reduction in the ORION II interacts somewhat with the digital AGC system. Here is why: when turning on the noise reduction, without changing digital AGC, the receiver will get very quiet, very quickly. This is not the desired effect of noise reduction! The desired effect is to identify what is signal and what is noise and improve the ratio between the two, rather than making the whole receiver quieter, signals and noise. When DSP NR is selected, digital AGC artificially reduces the threshold setting of the digital AGC – and you will notice that the overall noise level can **increase** – but **signal-to-noise ratio improves** and that is the ultimate goal of the NR system.

In practical terms, how does it work? There are 9 different settings, and each of the 9 is used to determine only **how aggressively (quickly) the NR adapts and identifies what is signal and what is noise.** Here is the rub (and it's logical): with weak signals, it is harder for any DSP NR system to determine what is noise and what is signal. When turning DSP NR on with a setting of "1" with a signal that is very weak, it's going to take a **very long time** for the algorithm to figure out what is signal and what is noise. For a somewhat louder signal (20 dB or more above the ambient noise level, still fairly weak) – a setting of "1" will adapt very fast! What is needed for weak signals is **more aggression.** By starting the NR at "3" or "4", the NR will more quickly adapt to what is signal and what is noise for a weak signal. **Once the NR has adapted, for the same signal, no change in NR will be made when adjusting the value!** If you

turn the DSP NR on, and just cycle through the values looking for "best" – nothing will happen. Because the DSP NR builds a bandpass filter to automatically reduce noise, it produces the same effect as manually selecting a very narrow DSP passband filter.

Perhaps nothing is more important than AGC setting, and **for single signal weak signal DXing purposes the programmable AGC value is probably the only setting that the operator should consider using.** We suggest using AGC hang at either 0.00 or a very small value like 0.04. Why? Because with AGC hang, AGC will grab onto the most recent noise peak and will adjust gain to it for the hang period. After that, decay will begin – this is **not good** if you're trying to listen to a signal at the noise floor and band noise is varying on top of the signal! It has been argued by operators of the original ORION that a small amount of hang may be desirable to keep the AGC action 'smoother' than it would be without hang. This is plausible – but again depends on the individual and the situation.

The **threshold** value in the AGC system acts like an IF gain control for the DSP section of the receiver chain – turn the value low (like to .37 uV) and the receiver gain comes up, as do the signal levels.

The threshold value can also be used to determine (limit) the top end of available receiver gain for the digital part of the receive chain. Setting the threshold value higher in turn imposes that higher limit on the available range of the RF GAIN control. Example: Listen to band noise with the threshold set to the lowest value (0.37 uv) and the RF GAIN set at 100. With these settings, receiver gain is at maximum.

Adjust threshold value to a higher value, like 31.91 uv. Note how overall receiver noise has dropped with the gain reduction. The top end of the available range of the RF GAIN control (which is still set at the highest value) is now limited by the threshold value rather than the entire actual available range of the receive chain.

The crucial part is adjusting **decay** and **threshold.** **Decay** is used to determine how fast the IF gain increases in the absence of a signal above the **threshold** value. For a

conventional setting like “fast”, **either on ORION II or any other transceiver**, the AGC can actually clip both a weak signal and the noise! Want an example? Tune to a point on the band where there is no signal, only band noise. Set AGC hang at 0.00, threshold at .37 uV, and then start decay rate at 5 dB/s. Turn it up to 2000 dB/s (fastest setting). Hear the background noise change? That’s AGC clipping the noise at the fast decay setting.

If there’s a weak signal in there at that level – you guessed it, the signal gets clipped too.

How to use the programmable AGC for optimum performance for weak signal DXing: There are two possibilities. For each, set hang value at 0.00 or 0.04. The first example we’ll call “quick decay, variable gain” Set the **decay** to 60 dB/s (which is still fairly fast) and the **threshold** at .37 uV while listening to a weak signal. As you increase the **threshold** to higher values, it is possible that the weak signal will come out of the noise as the system gain decreases and the AGC no longer clips the weak signal and the noise. The other method is “low threshold, varied decay” to set **threshold** at a low or the lowest value for maximum IF gain, and then use the **decay** control to adjust, starting from the slowest setting of 5 dB/s and working upward. As decay goes faster, it introduces clipping. When listening to a weak signal with **threshold** low, advance the **decay** until the point clipping starts (audible change in the noise component and/or loss of copy of chopping of the weak signal) – ideally, you want to adjust this to just before the clipping point for maximum copy of the weak signal.

So, all that being said, how about a “set-it-once-and-leave-it” value for programmable AGC for weak signal DXing?

Set AGC hang at 0.00, decay at 40-60 dB/s, and the threshold at .5 uV. This ought to provide a good enough combination of settings to allow just about anything that can be audible to be detected by the radio (and likely copied as well) and allow for plenty of gain. If you need just a little more, you can go in and change the AGC parameters for a given situation as described above.

While you can have an optimal starting point for programmable AGC – every signal and

every noise situation is unique! This is precisely what makes this system so advantageous over traditional settings of “fast” and “off”.

Updated February 2005 in the original ORION manual and reproduced here for ORION II owners’ benefit: *Anecdotal evidence from weak signal DXers using the original ORION transceiver over the past two years has suggested that for the very weakest of signals, some AGC hang may be desirable to hold the AGC level constant in the presence of varying noise. As every noise situation and signal condition is unique, it is possible for some operations that the weak signal (rather than the most recent noise peak) can hold the AGC constant and allow the very weakest of signals to be copied. This will vary with the conditions, and with the operator themselves for desirability.*

A practical example from a leading low band DXer for listening to very weak signals in band noise (no lightning or unusual atmospheric QRN) on 160 meters is to adjust the RF GAIN control upward until normal band noise is present. Set decay at a very low value (e.g. 5 dB/s) and adjust hang between 0.3 and 1.0 for best signal-to-noise ratio. Lightning QRN would be a different scenario – perhaps using fast AGC with hang at zero and RFGAIN backed down to limit extraneous noise.

Consider the settings we have suggested for single signal DXing: wider roofing filter, NR (if desired) at a start value of “3” or higher, use of programmable AGC, DSP bandpass filter set at any value desired. Now consider what we started with above: conventional settings on a past transceiver of 250 Hz crystal filter, AGC fast or off, DSP NR on. Let’s say on Orion, you’ve put in the 300 Hz roofing filter, put the DSP BW at 100 Hz, turned the AGC to fast or off, put the DSP NR on “1”, and then went to copy a single weak CW signal on the low bands. Knowing what you now know, what is the likely result? Not much chance that desired signal is going to be as copyable (or copyable at all!) as it would be with setting the transceiver to take it to its full capabilities.

To summarize for weak signal, single-signal DXing: Use the programmable AGC settings in the table above, adjusting if needed for each situation to enhance weak signal copy. Use the narrow roofing filters only if a loud signal is close enough to warrant it. Gain does not vary for DSP bandpass filters – use any value down to 100 Hz you feel comfortable with. For weak CW signals, either leave NR off or start NR at a setting of “3” or “4” for quicker adaptation. Make sure the narrow roofing filters, if you choose to use them, are centered using the C.F. controls in the menu. **Make sure the signal you are listening to is zero beat at the CW offset you have selected.**

Contest operation is a little different. Generally, contesters will not want to be fiddling with controls during the course of the contest like DSP NR, AGC, etc. unless it's to quickly adjust some parameter for a given situation. The needs of the contester are somewhat different from the single signal DXer. The contester needs the radio to be set for a somewhat optimum set of values to meet these criterion: 1) the ability to copy both weak signals and loud signals with AGC good enough to minimize the output variability between the two. 2) The minimization of loud nearby signals having an effect on overall receiver performance and 3) having an reasonably optimum “start” setting that will keep the operator from having to constantly adjust controls on the radio.

Now, these goals are not common to single signal DXing. **At first thought, it would seem that what would be good for single signal weak signal DXing would also hold true for contesting** – and perhaps for previous transceivers there was an element of truth to that. Actually, though, what would be good for copying a varying ratio of signal strengths under crowded band conditions is not at all the same as copying one weak signal with a Beverage receive antenna under quiet (non-contest) conditions.

Recommended start settings for CW contesting: In the filter menu, set **Xtal Filter** to AUTO. This will bring in the desired mode-appropriate roofing filter automatically as you adjust the DSP BW filter settings

across the value of the roofing filter. Likely loud signals are going to be present nearby, and minimizing them as a factor in overall receiver performance is paramount. This is where **every other radio fails** under contest conditions. That S9+30 dB CQer 3 kHz up the band from you? It's **killing** the receiver performance of other radios, even though the operator doesn't hear the signal through the **bandwidth** filter. With the narrow roofing filter, the **ORION II has no negative reaction to the same signal** – preserving receiver performance down to the smallest bandwidths needed for optimal contest operation.

Programmable AGC can also be of tremendous value as it gives the operator the ability to determine **in their head** what large signal strengths can be accommodated. It also will prevent fast AGC action from chopping up weak signals present in the passband, which can happen with conventional AGC settings.

Setting programmable AGC value is a little more tricky for contest operation. Obviously, you want a good amount of gain through the system, but limit the ability of strong signals to “blast the operator” in between listening to the weak ones. Setting the AGC hang value again to 0.00 or 0.04, a good starting point for threshold value would be approximately 1 uV with decay at a somewhat slow value to prevent signal clipping of the weak ones as noted in the weak signal DXing adjustments for programmable AGC. This will allow good copy of the weaker signals but allow the AGC system to compress loud signals and give uniform signal output for both the weak and loud signals. Of course, there are times when digging out the weak ones is part of contesting as well, and the prog AGC settings for weak signal DXing may be of use, but setting the most optimal AGC setting for any one signal is not always the most practical during a contest. **Setting programmable AGC at 0.00 or 0.04 hang, 20 dB/s decay and 1 uV threshold is a good starting point** but individual operators will want to vary them according to taste and to account for what band you're operating at the moment.

Where do I set the DSP NR? Obviously, with signals coming in and out, if you choose to use NR it should be at a higher setting

like “3” or “4” to allow very quick adaptation of each appearing signal. Setting it very high to start could result in signal distortion (particularly on SSB), but setting the value too low may not allow it to act quickly enough on the weaker signals. There is another choice, of course, and that is to simply leave it off – and with the ORION II’s receiver capabilities individual operators may find this to be the best choice of all. Remember, like all adaptive DSP noise reduction, sometimes it helps, sometimes does nothing, sometimes hinders. It all depends on signal and noise at that particular moment. Each operator will use or not use it to taste.

EXTERNAL CW OUTPUT PLUS CW KEYS OPERATION FROM PADDLES

Some contest logging programs use computer generated CW for transmission of contest data (CQ’s, reports, etc.) but do not employ the ability to send CW through any device other than input from the computer keyboard.

It is useful in this situation to be able to have both an external keyer (in this case, the computer) and the internal keyer in the ORION II both simultaneously available. The “external keyer” is used for contest CQ’s and information, while a paddle connected to the internal keyer can be used by the operator for quickly repeating necessary information.

Pin 3 on the AUX I/O connector on the ORION II rear panel is a PTT connection. In CW modes, this can allow the radio to be keyed by an external device in CW mode.

There is a menu item located in the **CW MENU** titled **PTT in CW as**. When this line item is set to “key”, a CW signal from an external source can be injected into either the mic jack or pin 3 on the AUX I/O cable on the rear of the radio. Connect the output of the external keyer to pin 3 on the AUX I/O connector or the PTT connection on the mic jack. Connect your paddle either to the front panel or rear panel key connector and use the SP button to enable the internal keyer. ORION II will now transmit CW either through the pin 3 input or using the paddles and internal keyer.

DRAG ADJUSTMENT FOR MAIN TUNING KNOBS “A” AND “B”

The two main tuning knobs have individual *drag* controls. To adjust the drag on either tuning knob, hold the silver skirt still while rotating the knob about a quarter turn. There will be a gentle “click” feel as each knob is loosened or tightened. Counter-clockwise twisting will loosen them and clockwise twisting will increase the drag. Loosen them up or increase the drag to your preference.

INSTALLATION OF OPTIONAL CRYSTAL ROOFING FILTERS

In addition to the four stock roofing filters of 20, 6, 2.4 and 1 kHz, there are three optional roofing filters available for the ORION II. 1.8 kHz (model 2000), 600 Hz (model 2001) and 300 Hz (model 2002).

Field installation of these filters is relatively simple.

Remove the top cover of the transceiver. Facing the transceiver, the filters are located at the top front left of the transceiver. There is a metal shield in place over the filters held by a single screw – remove this using a Phillips screwdriver. The optional filters are plug-ins and each filter location is marked.

The filters **MUST** be installed with the correct orientation and with the supplied insulator under each filter. Incorrect orientation of filters and/or leaving off the insulator under the bottom can result in damage to the transceiver.

Two of the pins on the bottom of the filter are grounded to the filter case; two are not. Look at the bottom of the optional filter. Two pins are soldered to the filter case, two pins are ‘open’. If you are facing the front of the transceiver and holding the filter, the grounded pins that are soldered to the filter case should be closest to you and the front of the radio; the two ungrounded pins should be furthest away from you towards the back of the radio.

Plug in the filter, assuring correct orientation and that the insulator is under the filter to keep it slightly elevated from the filter circuit board. Re-attach the filter shield over the filters and re-install the transceiver top cover.

After installation, the filters must be enabled via the menu system to be used. See the description provided in Chapter 3 under **(FILTR) FILTER MENU**.

MASTER RESET

On rare occasions, it may be possible to confuse the microprocessors in the transceiver to the point where a master reset may be necessary to restore operating state. A master reset also usually needs to be done after an upgrade for the transceiver is sent via the serial port interface (see the section titled **UPDATING YOUR RADIO OVER THE INTERNET** elsewhere in this chapter).

To perform a master reset, turn transceiver power off. Press and hold the MAIN RX/TX button in the ANT 1 column on the far left side of the radio (this button is described as number **2** in Chapter 2 of this manual). Turn transceiver power on, and continue to hold the MAIN RX/TX button in the ANT 1 column until the message "Master Reset Complete" appears on the bottom of the radio screen. This should take about 5 seconds after turning radio power on.

A prompt will appear at the bottom of the screen reading "Clear User Settings?" The *User Settings* are the 200 VFO memories (see description of **(49) and (52) VFO A>M and VFO B>M** in Chapter 2) and the profile memories stored in the USER 1-4 locations (see **(21) USER 1 and USER 2** in Chapter 2). Pressing YES by utilizing the AN button will clear out any previous user-entered data. Pressing NO by utilizing the RECALL button will restore ORION II to default settings without disturbing the user memories.

If you answer the "Clear User Settings?" prompt with YES, ORION II will then bring up a prompt reading "Clear Filter Settings?" to the screen. These settings pertain to the centering of the optional 600 and 300 Hz crystal filters (See **(FILTR) FILTER MENU** in Chapter 3). If you have these filters installed and centered, you will probably want to answer NO to avoid repeating the process.

UPDATING ORION II OVER THE INTERNET

One of the revolutionary features of the ORION II is the ability to upgrade any

existing transceiver to the latest version of the radio.

To check what version of the firmware you presently have installed in ORION II, either read the screen when first powering on the transceiver, or with the power on press and hold the MENUS button for two seconds.

Ten-Tec's firmware update site is located on the Internet at URL **www.rfsquared.com**

To upgrade your transceiver, visit the **www.rfsquared.com** web site and click on "Get The Latest For Your ORION II". A link will be available with the latest firmware version. This link will be titled with the date and the available version number of the firmware. Example: "10/19/05 Orion II Firmware Version x.xxx Available For Download".

Connect the DB-9 serial port connector on the back of ORION II to an open serial port on your computer with a standard serial port cable. From **www.rfsquared.com**, download the file. Note to which folder on your hard drive the file is being downloaded.

This file is an .exe executable. The executable file will have a set of step-by-step instructions. Go to the folder where you have downloaded the .exe file, and double click it to execute.

Follow the instructions provided, and send the new version of the firmware over to your transceiver.

Suggestions for new features for ORION II are always welcome – feel free to contact us.

TROUBLESHOOTING

While we cannot cover every possible problem, here are some hints for dealing with some potential difficulties.

Check the obvious. Is your dc power source okay? Check power supply, cable and connector(s). Is the 25 ampere fuse loose or missing? Antenna problems? Try a dummy load. Is a proper antenna connected? Is any external antenna switch connected and properly set? Have you checked ORION II's control settings? Have you double-checked ORION II's many control settings, including those on all MENUS

screens, for your intended mode of operation?

Problem: No audio from receiver

If you are using the SUB Rx, does it have a VFO and an ANT assigned?

If frequency controls act normally --

Which receiver are you controlling at the moment?

What routing is set in the AUDIO menu?

If S-meter seems to be reacting to signals --

Is receiver squelched? Check squelch threshold in the RX menu. Check setting of RF gain controls for main or sub receivers.

Try a set of headphones in case the speaker has failed.

Is either receiver muted from pushing the SUB AF or MAIN AF encoders? Is the volume on either turned all the way off?

Check inside the cabinet for cable connectors that may have loosened in shipment or rough handling.

Problem: Distorted SSB transmit

Be certain the mic gain is set properly. The ALC LED should flash on voice peaks, but not remain continuously lit.

Check the setting of the speech processor. An excessively high setting can reduce audio quality.

A frequent cause of a distorted SSB signal is inadequate RF grounding resulting in RF feedback. Common RF grounding problems are no ground connection, or too long a lead to a good ground. Many problems relate to the lack of an RF station ground, as contrasted with a safety ground connection. We recommend bonding all equipment chassis together with short heavy metal braid or strap. Make these connections from chassis ground lug to chassis ground lug and connect the last piece in the chain feeding the antenna to a good earth ground. This lead needs to be as short as possible. Lengths near $\frac{1}{4}$ wavelength on any band used can be particularly troublesome when the far end is connected to earth.

Another potential cause of distorted SSB arises when the station is in the near field of the antenna. This is a problem many apartment dwellers face.

Distorted SSB transmit can result from chassis ground and signal ground from the microphone being tied together to a common connection. This is a common problem with third-party microphones. Assure the chassis ground and signal ground from the microphone are separated.

Problem: No transmit, but receiver(s) OK

Is one of the TX LED's on the buttons to the far left of the transceiver lit? See the discussion of buttons **8** and **9** as described in Chapter 2. If neither of these two buttons is lit, the radio will not transmit.

The transmitter can be disabled in the TX menu (see Chapter 3). Make sure it has not been disabled.

Is the gain setting correct for the microphone input or AUX I/O as appropriate?

Is the KEYING LOOP set properly for your mode of operation? With no amplifier or with a non-QSK amplifier the menu should indicate keying loops are turned off. If either of the two keying loops are enabled and no connection is made to them, the radio will not transmit.

Is the PWR control turned up to an appropriate value?

Problem: No receiver(s), transmit OK

Check the PBT setting or turn it off. It may be set outside the passband.

Disconnect any external equipment that might be pulling the PTT line MIC or PBT connector to ground.

Is the internal KEYER enabled with a mono plug in the KEY jack? That would cause a constant stream of dits when you apply power.

Check settings of the squelch in the RX menu and the AF and RF gain controls.

Problem: No operation in VOX

Check the ORION II screen to see if the menu items for VOX are active and set

properly. If any of the three settings is at zero, VOX will not operate.

The Ten-Tec model 701 hand microphone will not operate in VOX mode.

The mic element in other (non-Ten-Tec) microphones must be active (open) when used in VOX mode with ORION II. This generally means locking the PTT on the microphone after putting the radio into VOX mode – but every mic is different. Consult the operation manual of your microphone.

Problem: Step size selected is always one level higher than desired and 'xm' appears above it on the screen.

Consult the section of the manual titled **(55) SUB RX** and **(56) MAIN RX**. The 'quick

jump' step size function has been enabled. It can be disabled by pressing an already lit MAIN RX or SUB RX button.

If the above does not solve your problem, please consult with our service department (865) 428-0364 or via service@tentec.com

Chapter 5 – SPECIFICATIONS AND TECHNICAL DESCRIPTION

566 ORION II HF TRANSCEIVER – SPECIFICATIONS

GENERAL:

Frequency range:

SUB RX 500 kHz-30 MHz, Specifications apply > 1.8 MHz;
TX & MAIN RX 1.8-2.0, 3.5-4.0, 5.25-5.40, 7.0-7.3, 10.1-10.15, 14.0-14.35, 18.068-18.168, 21.0-21.45, 24.89-24.99, 28.0-29.7.

Tuning Step Sizes: 1, 10, 100, 1k, 5k, 10k and 100 kHz

Frequency Stability: ± 3 PPM over operating temperature. TCXO is standard.

Rated RF Load: 50 ohms nominal @ 2.0:1 maximum SWR.

Antenna jacks: 2x SO-239 transceiver, 1x RCA-style phono female receive only.

Modes: USB, LSB, AM, FM, CWUSB, CWLSB, FSK, Panoramic Stereo™ (Binaural w/spatial perception).

I-Fs: Main RX & TX - 9 MHz, 450 kHz, 14.0 kHz;
Sub RX - 45 MHz, 450 kHz, 14.0 kHz.

Display: 320 x 240 pixels, TFT color screen with CCFL backlighting.

Freq. Control: Receivers operate on any two bands simultaneously; transmitter can be assigned to either receiver.

Supply Voltage: 13.8 Vdc nominal. Reverse-polarity & over-voltage protection standard.

Operating Temperature Range: 0-50° C

Dimensions (H x W x D): 5.25" x 17.0" x 18.75" (13.3 x 43.2 x 47.6 cm)

Weight: 20 lb. (9.2 kg)

Construction: Al chassis, steel cabinet, glass-epoxy printed-circuit boards.

PC control port: EIA-232 standard, DE-9F.

The following features & specifications apply to both receivers:

Digital AGC systems: Programmable AGC threshold, hold, & decay times, fast attack. Independent controls for each receiver.

Passband Tuning: Independent controls for each receiver.

RX Audio Equalizers: Bass/treble boost/cut up to 6 dB/octave.

RX Audio Output Power: 2 W into 4 ohms, < 3% THD.

Line-level Output: 0 dBm into 600 ohms.

RX Notch Filters: IF DSP, > 50 dB depth, adjustable width. Notch affects S-meter.

Auto-Notches: IF DSP, Multi-tone, adjustable on each receiver.

RX Noise Reduction: IF DSP, adjustable on each receiver.

MAIN RECEIVER:

SSB Sensitivity: <0.18 μ V typical for 10 dB SINAD at 2.4 kHz BW, pre-amp on.
<0.5 μ V typical for 10 dB SINAD at 2.4 kHz BW, pre-amp off.

AM Sensitivity: <1.50 μ V for 10 dB SINAD at 6.0 kHz BW, 30% modulation, 1 kHz, pre-amp off.

FM Sensitivity: <2.50 μ V for 12 dB SINAD at 20 kHz BW, 3-kHz deviation, 1 kHz, pre-amp off.

Selectivity–1ST I-F: Standard 9-MHz-IF crystal filter BWs - 20 kHz, 6 kHz, 2.4 kHz, 1.0 kHz
Optional crystal filter BWs - 1.8 kHz, 600 Hz & 300 Hz. Automatically selected via DSP BW or under independent control.

Selectivity –DSP IF: 590 built-in DSP filters from 100-6000 Hz

Selectivity – FM: 20 kHz.

IP3 (Third Order Intercept Point): +25 dBm typical - 20-kHz spacing at 2.4 kHz BW, pre-amp off;
+24 dBm typical - 5-kHz spacing, BW 500 Hz, pre-amp off.

IMD3 Dynamic Range: 101 dB typical, pre-amp off, 20-kHz and 5-kHz spacing.

IP2 (Second Order Intercept Point): +75 dBm typical.

LO Phase Noise: -136 dBc/Hz typical from 0.5-20 kHz offset.

Image Rejection: >70 dB.

IF Rejection: >70 dB.

Other Spurious Response Rejection: >90 dB, F>1 MHz.

Internal birdies: None stronger than specified sensitivity.

Current drain: 2 A typical, audio reduced.

RIT range: \pm 10 kHz.

S-meter Reference: S9 = 50 μ V.

TX > RX Recovery time: < 20 ms

Noise Blankers: Two independent noise blankers:
9 MHz - Hardware - on/off.
IF₃ - DSP, adjustable.

SUB RECEIVER:

SSB Sensitivity:	0.35 μ V typical for 10 dB SINAD at 2.4 kHz BW.
SSB & CW Selectivity:	590 IF DSP filters - 100-6000 Hz BW.
AM Selectivity:	IF DSP filters – 4 & 6 kHz.
FM Selectivity:	Ceramic filter - 15 kHz.
IP3:	+5 dBm typical, 20-kHz spacing.
IP2:	+71 dBm typical.
Image Rejection:	> 70 dB.
IF Rejection:	> 70 dB.
S-meter Reference:	S9 = 50 μ V
Recovery Time:	< 20 ms.
Noise Blanker:	Software, adjustable 0-9.

TRANSMITTER:

Power Output:	ALC Adjustable 5-100 W, \pm 1 dB.
Telegraphy (CW) & SSB Duty Cycle:	continuous service @ 100W
AM, FM, AFSK, PSK Duty Cycle:+ (constant-carrier modes):	continuous with cooling fan accessory.
Microphone Input Impedance:	>10 k-ohms at 1 kHz.
Microphone Sensitivity:	5 mV for full power output; Internal gain-range adjustment; dc power for electret elements.
Line-level Input:	6 dBm into 600 ohms for full output.
Speech Processor:	RF compression - 0-9 adjustment.
TX Bandwidth:	900-3900 Hz in 10-Hz steps.
TX Frequency Response:	50-3900 Hz maximum @ 6 dB points, adjustable.
TX Equalizer:	Up to 6-dB/octave; bass/treble boost/cut.
TX Speech Monitor:	Modulated IF after filtering, processing.
SSB Carrier Suppression:	> 50 dB.
Unwanted Sideband Suppression:	> 60 dB at 1 kHz.
Harmonic & Spurious Outputs:	> 50 dB below 100 W; > 40 dB below 5 W.
T/R Switching:	PTT or VOX on SSB, AM, FM, FSK; Adjustable QSK on CW
CW Keyer Speed Range:	10 -50 wpm, adjustable weighting.
CW Rise & Fall Times:	Adjustable 3-10 mS
CW Offset:	Programmable 100-1200 Hz in 10 Hz steps.

Sidetone pitch automatically matches selected CW offset.

XIT Range: ± 10 kHz

FM Deviation: ± 5 kHz peak nominal.

Current Drain: 25 A max.

HARDWARE INFORMATION

The transceiver comprises 13 printed circuit board subassemblies plus one optional subassembly, as Figure 5-1 shows:

Figure 5-1 ORION Subassemblies

Part #	Name	Designator
81908	Input/Output Board (I/O)	A0
81909	Low Pass Filter (LPF)	A1
81897	Power Amplifier (PA)	A2
81906	RF Converter (RFCNV)	A3
81910	9 MHz IF (IF)	A4
81911	I.F. Converter (IFCNV)	A5
81907	Subreceiver (SUB)	A6
81917	Logic and DSP (DSP)	A7
81913	Keypad (KEY)	A8
81936	Power Distribution Board (PWR)	A9
81912	Synthesizer (SYNTH)	A10
81916	Motherboard (MBD)	A11
81915	Rear Connector Board	A12
81957	Sweep Amplifier	A13
81956	optional Autotuner	A14

See Figure 5-2 for a block diagram showing the relationship of these subassemblies in the transceiver. A11, the motherboard, forms ORION's central electrical spine interconnecting all but two of the printed circuit boards (PCBs). For clarity, the block diagram does not explicitly show A11's myriad interconnections. Miniature coaxial cable and connectors carry essentially all signals between boards. Shield partitions suppress possible inter-board crosstalk.

Subassembly Location

The centrally located motherboard (A11) connects the logic board (A7), keypad board (A8), and other front panel parts with the I/O (A0) and rear connector (A12) boards which populate the rear panel. Along the way, A11 picks up DC and control line connections from A1, A4, A5, and A6 in 4 compartments above the chassis deck. Below the chassis deck, A3, A9, and A10 also connect to the Motherboard. The optional internal automatic antenna tuner (A14) connects via wires and plug-in cables to A0. Each signal-processing module has its own compartment.

Figure 5-3 maps the physical locations of these subassemblies in ORION's chassis.

A0 and A2 share the rear panel space, with each taking up most of the height and about half the width of the panel. The rear connector board (A12) shares the panel half dominated by the PA. It carries 5 connectors whose design suits them to mounting on a board perpendicular to the panel. Together with 19 connectors on A0, they comprise almost all of ORION's input/output connectors for DC, audio, control, and RF. The MIC, CW, and PH (headphone) jacks are in front.

Signal Path – Main Receiver

Figure 5-4 diagrams the path a main receiver RF signal takes from antenna to audio. A signal from one of ORION's 3 antennas enters one of the antenna jacks on the rear panel, where I/O (A0) selects the path to the RFCNV (A3) via cable 2. Amateur band preselection, pre-amplification, and high dynamic range conversion to the first IF take place in the RF converter.

From A3, cable 11 brings the IF signal to the 9-MHz IF (A4), where the hardware noise blanker operates in a wideband environment. Cables 14A and 14B route the wideband IF signal through the sweep amplifier (A13) to A7 for use in ORION's band scope feature. Four standard and three optional crystal filters (selected automatically by the BW control or manually in the menu system) define the tuned signal bandwidth ahead of DSP filtering. This stage provides enough amplification to maintain the receiver

sensitivity despite unavoidable filter losses. The amplified and band-limited signal feeds the IF converter board (A5) via cable 16.

A5 provides conversion to the 2nd IF, amplification, filtering, and conversion to the 3rd IF for processing in the A7 logic board. Cable 18 carries the 14 kHz third IF to the DSP in A7.

After digital signal processing in A7, the recovered audio travels through the motherboard to the headphone jack on A8 and to the EXT SPKR and AUX I/O jacks on A12. From A12 wire cable 36 runs to the internal speaker.

The synthesizer board (A10) supplies 1st local oscillator signal to A3 via cable 12, and 2nd LO to A5 via cable 19.

Signal Path – Subreceiver

For the subreceiver, the signal path starts at an antenna jack selected by the I/O board (A0) and proceeds to A6, the subreceiver board. This board comprises the entire analog circuitry of the subreceiver, accomplishing conversion of HF signals successively to 45 MHz, 450 kHz, and 14 kHz intermediate frequencies. 3rd IF signal travels to the DSP via cable 20. Audio from A7 goes through the motherboard (A11) to the headphone jack on A8. The audio signal also reaches the EXT SPKR and AUX I/O jacks via A11 and A12. From A12 it runs through wire cable 36 to the internal speaker.

The synthesizer board (A10) supplies a 2nd local oscillator signal and a frequency reference for the subreceiver's 1st local oscillator to A6. Cables 23 and 21 carry these signals.

Signal Path – Transmitter

The TX signal path has the MIC and CW (key/keyer) jacks on A8 as sources. Other sources are the KEY and AUX I/O jacks on A12. The audio signals from MIC and AUX I/O travel via cables 25 and 24 respectively. Keying lines get to A7 via A11.

From the DSP, cable 17 carries keyed or modulated 3rd IF to A5. The 9 MHz output from the IFCNV feeds A3 via cable 13. The resulting HF signal can go to the XVRTR RF

jack on the I/O board through cable 3, or to the PA (A2) via cable 8.

From A2 the path to the LPF board is via cable 7. Cable 27 brings the high level amateur band HF to AO, the I/O board. On the I/O board, the signal is routed to the selected ANT1 or ANT2 RF output connector.

If it is installed, the optional internal automatic antenna tuner (A14) is connected in the ANT1 path only. Cable 26 provides the A14 input path, and cable 27 is the output path. If the transceiver has no A14, cable 28 replaces the autotuner.

Figure 5-2 Subassembly Cabling

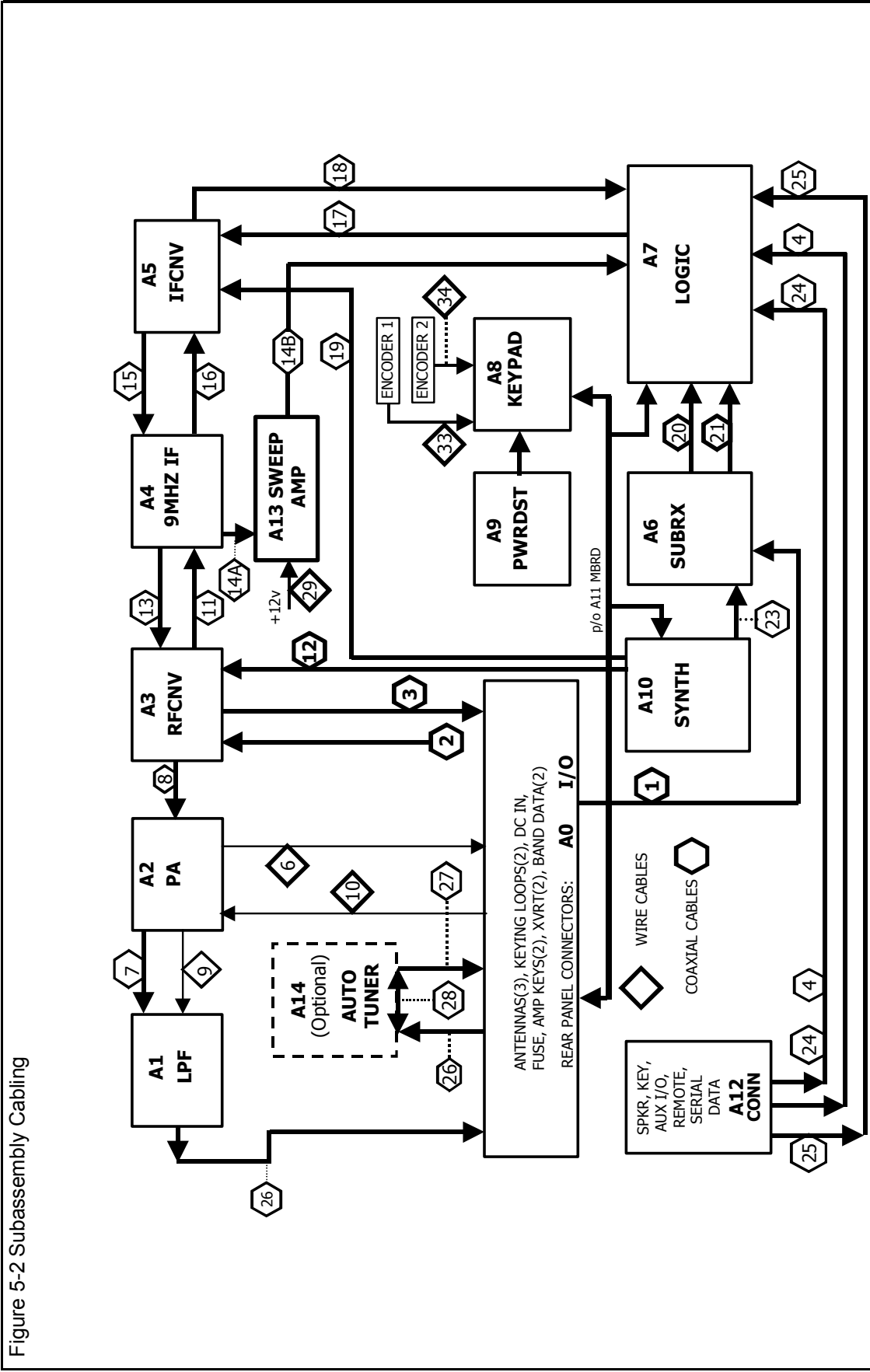

Figure 5-3 Plan View of ORION Chassis

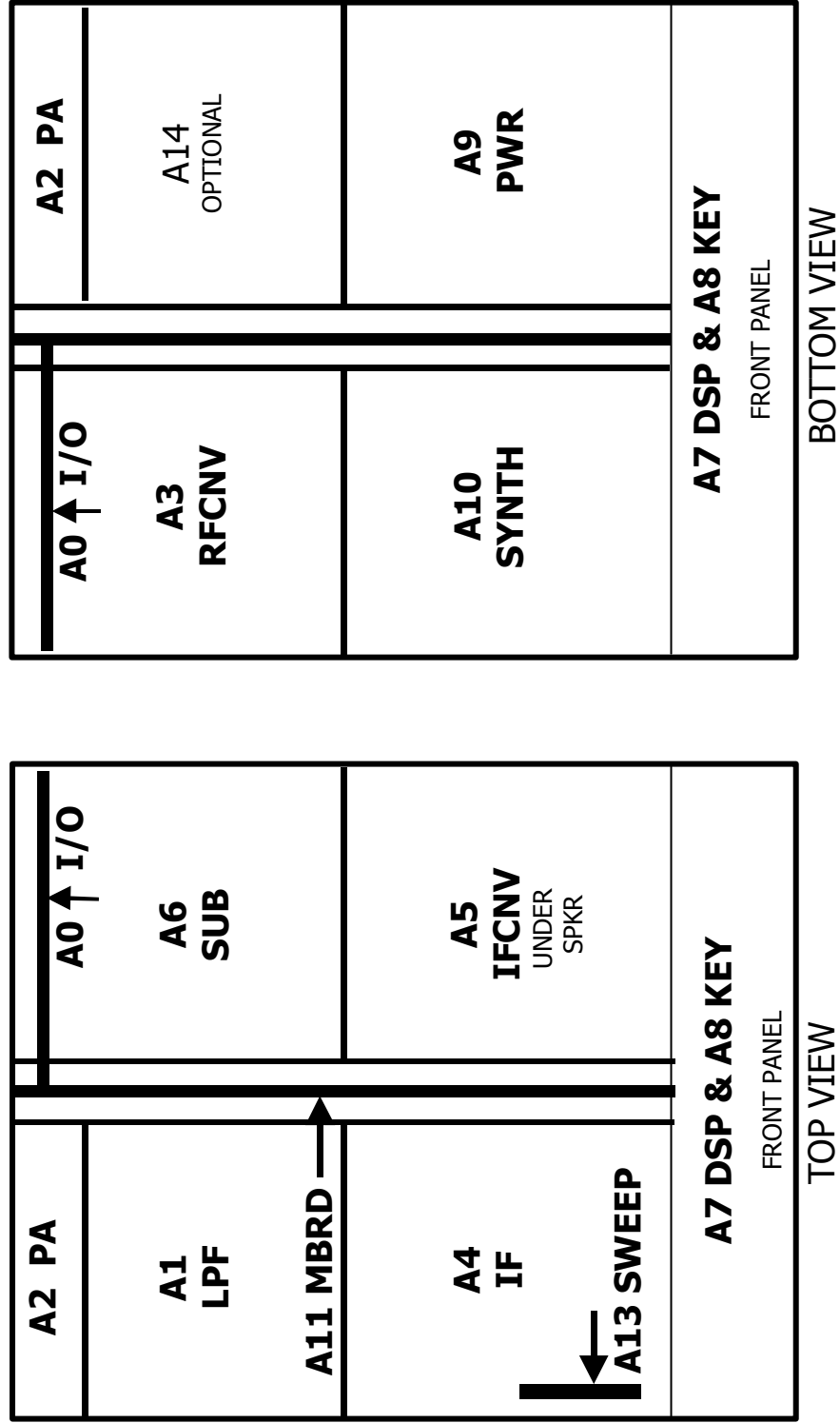

Figure 5-5 Subreceiver Signal Path

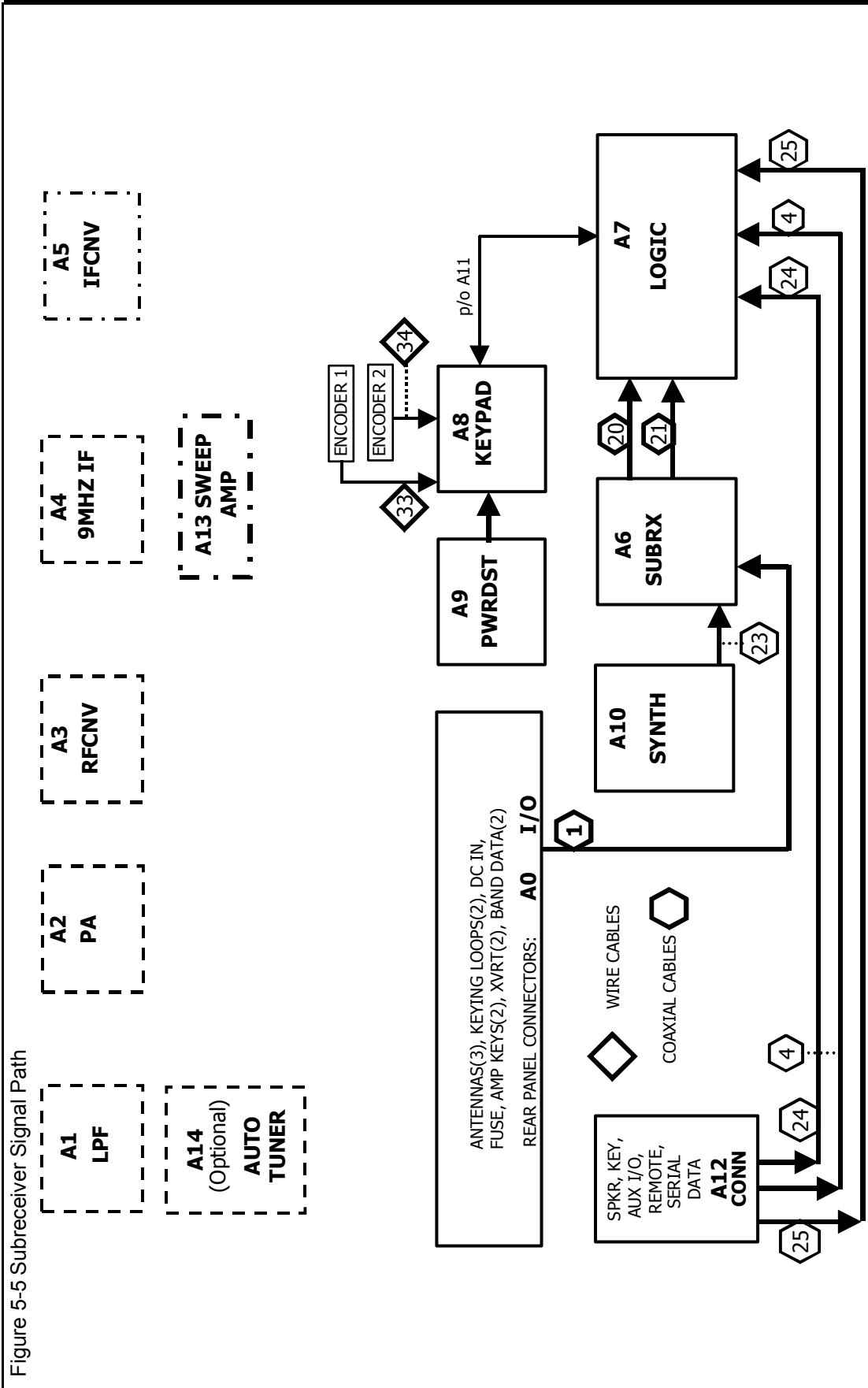

Figure 5-6 Transmit Signal Path

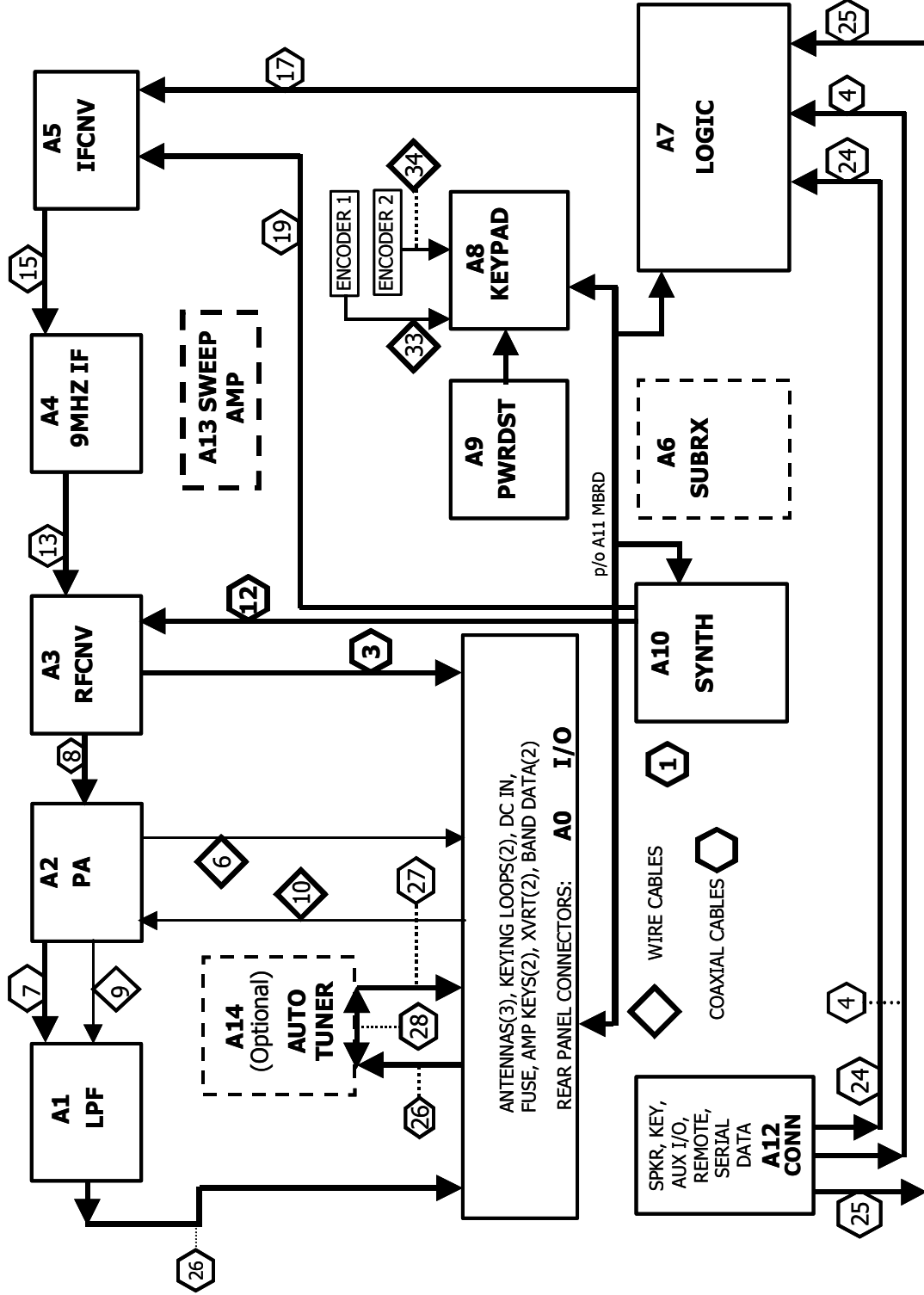

Figure 5-7 Major ORION Cables

Ass'y	From Name	Function & Direction	Type	To Name	Assy	ID #
A0	I/O	Sub Rx Ant In	RG174	Sub Rx	A6	1
		Main Rx Ant In	RG174	Main Rx	A3	2
		XVERT Out	RG174	Main Rx	A3	3
		Main Rx Audio Out	RG174	DSP/CPU	A7	4
		Tx RFOut	RG174	Lowpass	A2	5
A2	PA	PA Temp Out	2-3 Term	I/O	A0	6
		PA RF Out	RG188	Lowpass	A2	7
		PA RF In	RG174	Main RX	A3	8
		T-voltage Out	2-Term	Lowpass	A2	9
		13.8 V In	#16 Red	I/O	A0	10
A3	Main Rx	1st Rx IF Out	RG174	9 MHx IF	A4	11
		1st LO In	RG174	Synth	A10	12
		1st Tx IF In	RG174	9 MHx IF	A4	13
A4	9 MHz IF	IF to Sweep Amp	RG174	Sweep Amp	A13	14
		Main Sweep In	RG174	Sweep Amp	A13	14A
		1st IF Out	RG174	IF Converter	A5	15
A5	IF Conv	3rd Tx IF In	RG174	DSP/CPU	A7	17
		3rd Rx IF Out	RG174	DSP/CPU	A7	18
		Main RX LO Ref	RG174	Synth	A10	19
A6	Sub Rx	Sub Rx 3rd IF Out	RG174	DSP/CPU	A7	20
		Sub 1st LO Ref	RG174	Synth	A10	21
		Sub 2nd LO Ref	RG174	Synth	A10	23
A7	DSP/CPU	Aux Audio In	RG174	Conn	A12	24
		Mic Audio	RG174	Key Pad	A8	25
		Power Switch	2-Term	Pwr Sw		30
		S-Meter	4-Term	S-Meter		31
		CCFL Backlight	2-Term	CCFL	1-Wht-A 2-Blk-K	32
A8	Keypad	Encoder 1 Out	5-Term		Enc1	33
		Encoder 2 Out	5-Term		Enc2	34
A9	Pwr Dist	5V DC	2-3-Term	Dsp/CPU	A7	35
A11		Motherboard: Power & Control				PWB PWB
A12	Conn	Speaker	2-Term	Speaker		
A14	Tuner	Tuner RF In	RG188	I/O	A0	26
		Tuner RF Out	RG188	I/O	A0	27
		No-Tuner Jumper	RG188	I/O	A0	28

Schematic Diagrams

ORION's schematic diagrams are available as Adobe™ .pdf files on the company firmware update site located at www.rfsquared.com

